



## tab F design stefano conficconi 2022

modular sofa with wooden frame and elastic belts support. Seat cushion padded with three varying densities of polyurethane foam covered with siliconized microfiber. Metal back and armrest covered with polyurethane foam. Back cushion in siliconized microfiber, roll pillow made with polyurethane foam covered with an acrylic fibre layer. The tabletop is available in five ceramic finishes: calacatta white, marquinia black, arabesque, grey beauty, alpi chiaro. The coffee table is mounted on a matt painted metal support available in the following colors: RAL: 9005, 5020, 6026, 3003, 9002, 7030, 7024, 3007, 6008 and NCS: 2010Y70R, black chrome, polished chrome, or with a gold color finishing. Legs are made in alluminium.  
**NB:** The fabric upholstery is removable. The details in the edges of the seat can be made in a contrasting color upon request.

divano modulare con fusto in legno e supporto di nastri elastici. Cuscino di seduta imbottito con tre diverse densità di poliuretano espanso ricoperto con microfibra siliconata. Schienali e braccioli in metallo rivestiti in poliuretano espanso. Cuscino schienale in microfibra siliconata, cuscino rullo composto da poliuretano espanso rivestito in falda acrilica. Il top dei tavolini è disponibile in cinque finizioni di ceramica: calacatta white, marquinia black, arabescato, grey beauty, alpi chiaro. Il tavolino è montato su una staffa in metallo verniciata opaca disponibile nei seguenti colori. RAL: 9005, 5020, 6026, 3003, 9002, 7030, 7024, 3007, 6008 e NCS: 2010Y70R oppure cromata nera, cromata lucida o oro. I piedi sono in alluminio.  
 Note: la versione con rivestimento in tessuto è sfoderabile. Su richiesta è possibile realizzare i dettagli negli angoli dei cuscini di seduta con un colore in contrasto.

seat height	seat depth	arm width	arm height	feet height
altezza seduta	profondità seduta	larghezza braccio	altezza braccio	altezza piede
42 cm	57 cm	6 cm	65 cm	4 cm
16.5"	22.4"	2.4"	25.6"	1.6"

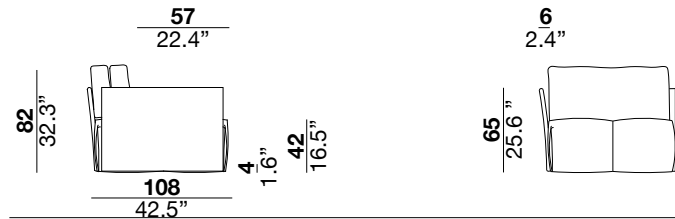

2

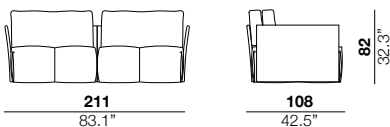

X

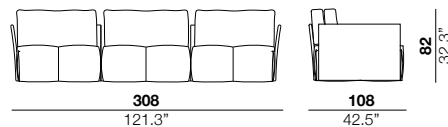

01



40



05/06

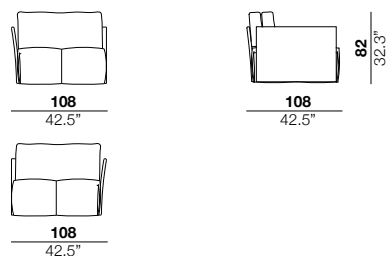

07/08

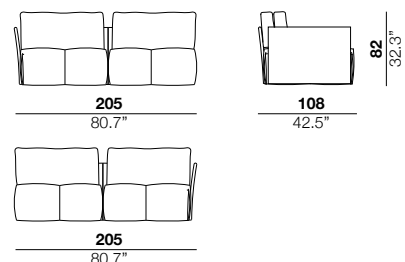

17G/18G

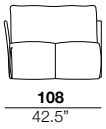

108  
42.5"

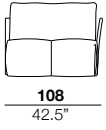

108  
42.5"

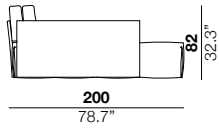

200  
78.7"

82  
32.3"

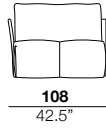

108  
42.5"

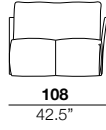

108  
42.5"

17P/18P

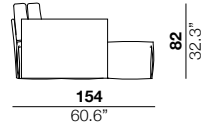

154  
60.6"

82  
32.3"

75/76

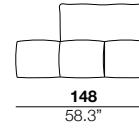

148  
58.3"

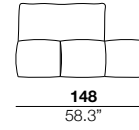

148  
58.3"

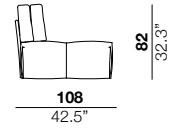

108  
42.5"

82  
32.3"

77/78

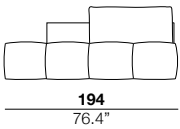

194  
76.4"

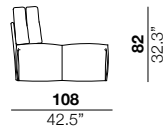

108  
42.5"

82  
32.3"

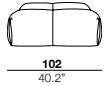

102  
40.2"

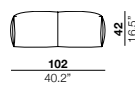

102  
40.2"

42  
16.5"

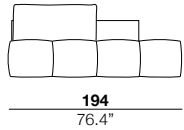

194  
76.4"

PQU???

05+01+18P

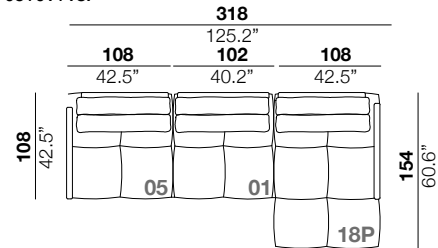

318  
125.2"

108 102 108  
42.5" 40.2" 42.5"

108  
42.5"

154  
60.6"

05+01+18G

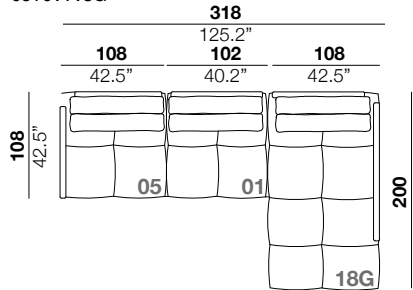

318  
125.2"

108 102 108  
42.5" 40.2" 42.5"

108  
42.5"

200  
78.7"

17P+75+P

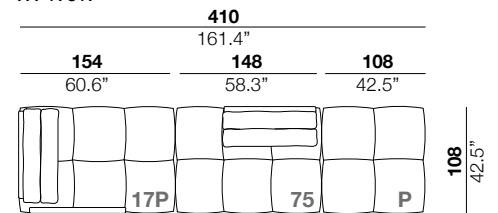

410  
161.4"

154 148 108  
60.6" 58.3" 42.5"

108  
42.5"

05+01+01+40+78

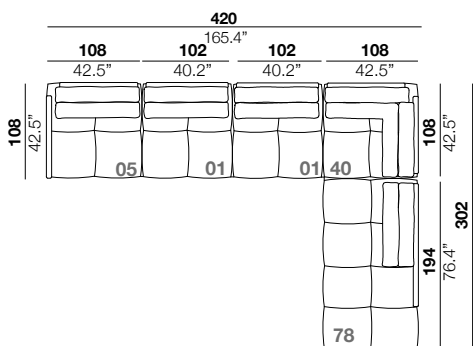

420  
165.4"

108 102 102 108  
42.5" 40.2" 40.2" 42.5"

108  
42.5"

108  
42.5"

118.9"

75+40+01+01+06

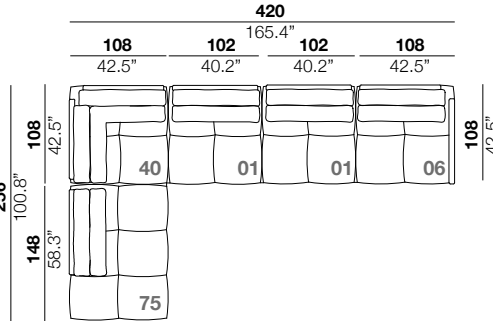

420  
165.4"

108 102 102 108  
42.5" 40.2" 40.2" 42.5"

108  
42.5"

256  
100.8"

108  
42.5"



## tab F cuoio design stefano conficconi 2022

modular sofa with wooden frame and elastic belts support. Seat cushion padded with three varying densities of polyurethane foam covered with siliconized microfiber. Metal back and armrest covered with polyurethane foam. Back cushion in siliconized microfiber, roll pillow made with polyurethane foam covered with an acrylic fibre layer. The tabletop is available in five ceramic finishes: calacatta white, marquinia black, arabesque, grey beauty, alpi chiaro. The coffee table is mounted on a matt painted metal support available in the following colors: RAL: 9005, 5020, 6026, 3003, 9002, 7030, 7024, 3007, 6008 and NCS: 2010Y70R, black chrome, polished chrome, or with a gold color finishing. Legs are made in alluminium. NB: The fabric upholstery is removable. The details in the edges of the seat can be made in a contrasting color upon request.

divano modulare con fusto in legno e supporto di nastri elastici. Cuscino di seduta imbottito con tre diverse densità di poliuretano espanso ricoperto con microfibra siliconata. Schienali e braccioli in metallo rivestiti in poliuretano espanso. Cuscino schienale in microfibra siliconata, cuscino rullo composto da poliuretano espanso rivestito in falda acrilica. Il top dei tavolini è disponibile in cinque finizioni di ceramica: calacatta white, marquinia black, arabescato, grey beauty, alpi chiaro. Il tavolino è montato su una staffa in metallo verniciata opaca disponibile nei seguenti colori. RAL: 9005, 5020, 6026, 3003, 9002, 7030, 7024, 3007, 6008 e NCS: 2010Y70R oppure cromata nera, cromata lucida o oro. I piedi sono in alluminio.

Note: la versione con rivestimento in tessuto è sfoderabile. Su richiesta è possibile realizzare i dettagli negli angoli dei cuscini di seduta con un colore in contrasto.

<b>seat height</b> altezza seduta 42 cm 16.5"	<b>seat depth</b> profondità seduta 57 cm 22.4"	<b>arm width</b> larghezza braccio 6 cm 2.4"	<b>arm height</b> altezza braccio 65 cm 25.6"	<b>feet height</b> altezza piede 4 cm 1.6"
--	--	---	--	---

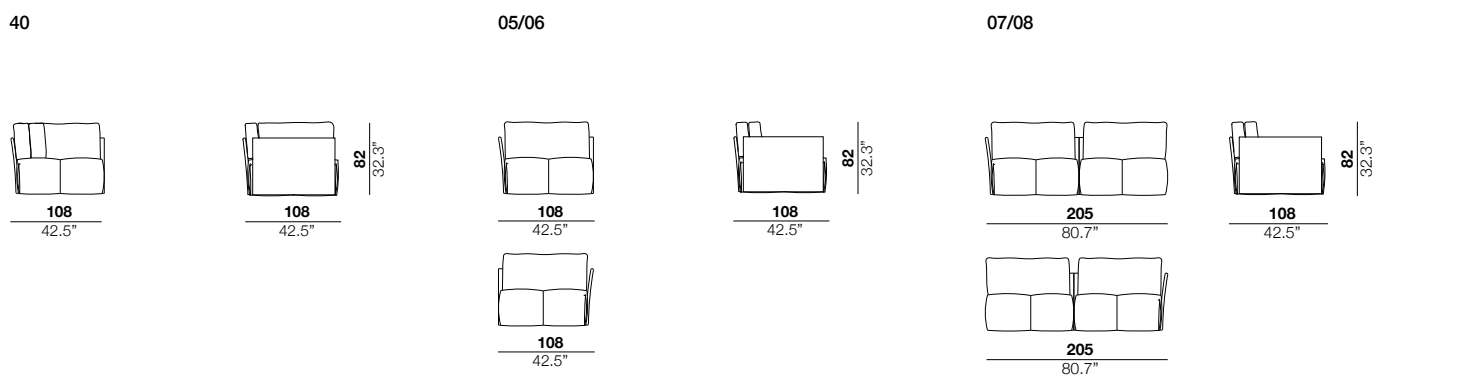
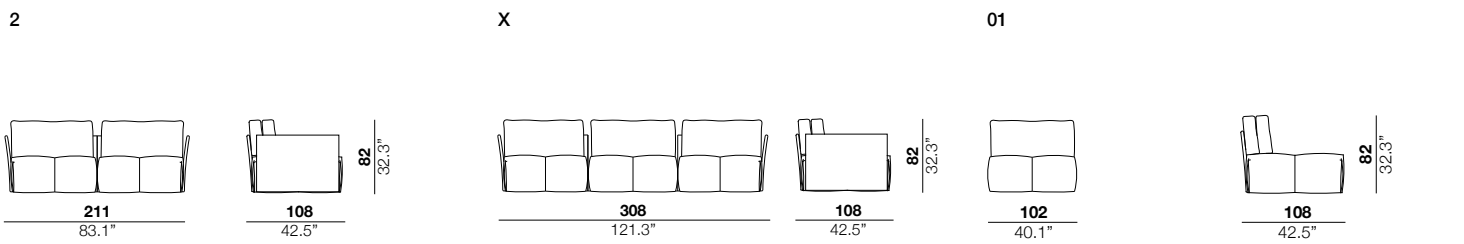
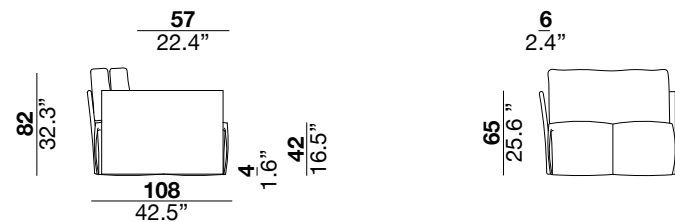

17G/18G

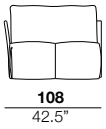

108  
42.5"

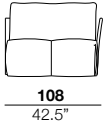

108  
42.5"

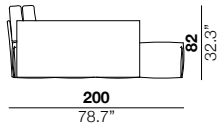

200  
78.7"

82  
32.3"

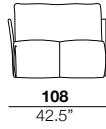

108  
42.5"

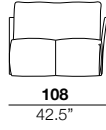

108  
42.5"

17P/18P

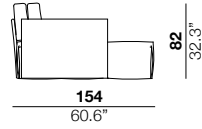

154  
60.6"

82  
32.3"

75/76

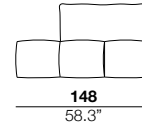

148  
58.3"

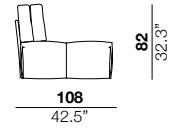

108  
42.5"

82  
32.3"

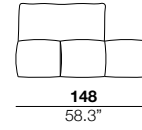

148  
58.3"

77/78

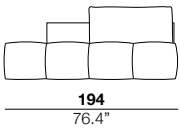

194  
76.4"

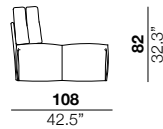

108  
42.5"

82  
32.3"

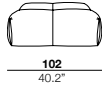

102  
40.2"

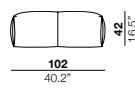

102  
40.2"

42  
16.5"

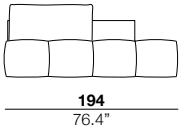

194  
76.4"

PQU???

05+01+18P

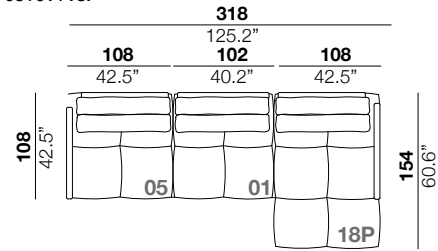

318

125.2"

108  
42.5"

102  
40.2"

108  
42.5"

108  
42.5"

154  
60.6"

05+01+18G

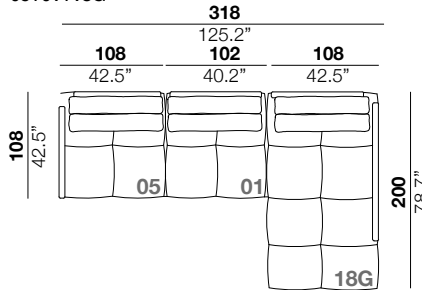

318

125.2"

108  
42.5"

102  
40.2"

108  
42.5"

108  
42.5"

200  
78.7"

17P+75+P

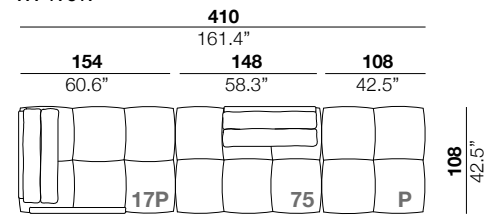

410

161.4"

154  
60.6"

148  
58.3"

108  
42.5"

108  
42.5"

05+01+01+40+78

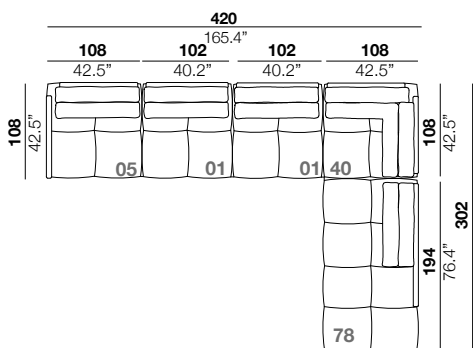

420

165.4"

108  
42.5"

102  
40.2"

102  
40.2"

108  
42.5"

108  
42.5"

108  
42.5"

118.9"

75+40+01+01+06

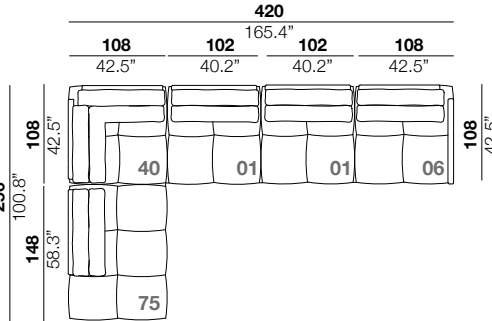

420

165.4"

108  
42.5"

102  
40.2"

102  
40.2"

108  
42.5"

108  
42.5"

148  
58.3"

108  
42.5"

108  
42.5"



## tab design stefano conficconi 2021

Modular sofa with wooden frame and elastic belts support. Seat cushion padded with three varying densities of polyurethane foam covered with siliconized microfiber. Two types of back are available:

–Metal frame with elastic belts, padded with polyurethane foam covered with an acrylic fibre layer. Equipped with an adjustable mechanism allowing the back to be opened and closed in two positions.

–Metal back/armrest covered with polyurethane foam.

Back cushion in siliconized microfiber, roll pillow made with polyurethane foam covered with an acrylic fibre layer.

Wooden armrest frame padded with polyurethane foam covered with siliconized microfiber. The tabletop is available in five ceramic finishes: calacatta white, marquinia black, arabesque, grey beauty, alpi chiaro. The backrest, armrest and coffee table are mounted on a metal support that can be placed on the four sides of the seat. The support is available matt painted in the following colors: RAL: 9005, 5020, 6026, 3003, 9002, 7030, 7024, 3007, 6008 and NCS: 2010Y70R, black chrome, polished chrome, or with a gold color finishing.

**NB: The fabric upholstery is removable. The details in the edges of the seat and back cushions can be made in a contrasting color upon request.**

Divano modulare con fusto in legno e supporto di nastri elastici. Cuscino di seduta imbottito con tre diverse densità di poliuretano espanso ricoperto con microfibra siliconata. Possibilità di scegliere tra due tipi di schienale:

–Telaio in metallo con supporto di cinghie elastiche, imbottito con poliuretano espanso ricoperto con falda acrilica. Dotato di un meccanismo frizionato che permette l'apertura e la chiusura dello schienale in due posizioni.

–Schienale/bracciolo in metallo rivestito in poliuretano espanso.

Cuscino schienale in microfibra siliconata, cuscino rullo composto da poliuretano espanso rivestito in falda acrilica.

Struttura bracciolo in legno imbottito con poliuretano espanso ricoperto con microfibra siliconata. Il top dei tavolini è disponibile in cinque finizioni di ceramica: calacatta white, marquinia black, arabescato, grey beauty, alpi chiaro. Schienale, bracciolo e tavolino sono montati su una staffa in metallo che può essere posizionata a piacere sui quattro lati della seduta. Le staffe sono disponibili verniciate opache nei seguenti colori RAL: 9005, 5020, 6026, 3003, 9002, 7030, 7024, 3007, 6008 e NCS: 2010Y70R oppure cromate nere, cromate lucide o oro.

Note: la versione con rivestimento in tessuto è sfoderabile. Su richiesta è possibile realizzare i dettagli negli angoli dei cuscini di seduta e schienale con un colore in contrasto.

<b>seat height</b>	<b>seat depth</b>	<b>arm width</b>	<b>arm height</b>	<b>feet height</b>
altezza seduta	profondità seduta	larghezza braccio	altezza braccio	altezza piede
42 cm	100 cm	50 cm	53 cm	6 cm
16.5"	39.4"	19.7"	20.9"	2.4"

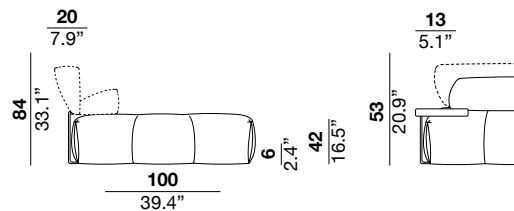

<b>seat depth</b>	<b>arm width</b>	<b>arm height</b>
profondità seduta	larghezza braccio	altezza braccio
71 cm	6 cm	60 cm
28"	2.4"	23.6"

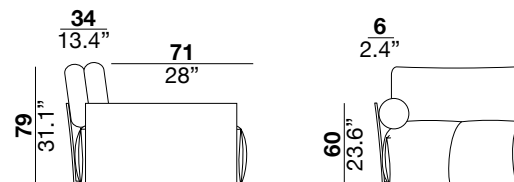

01

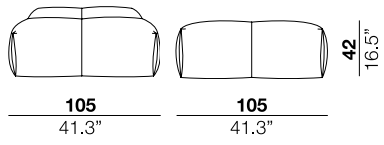

21

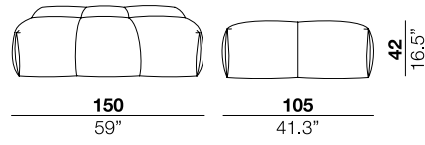

31

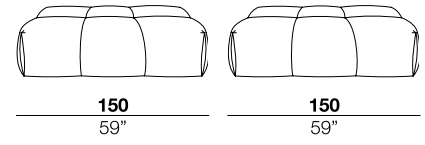

41

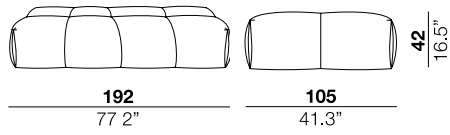

51

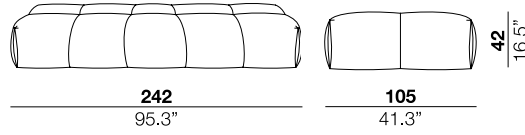

SQ2

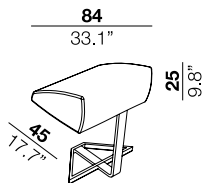

SQ3

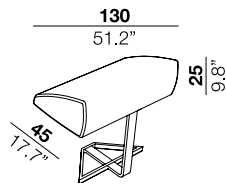

SQ4

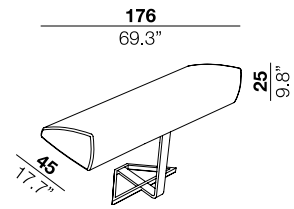

SQ5

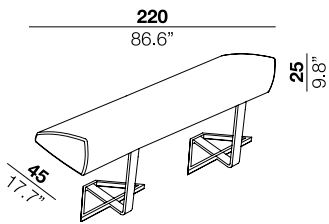

SQ6

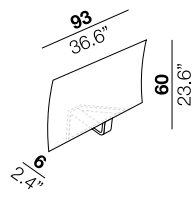

SQ7

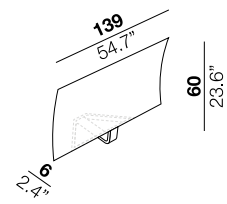

SK

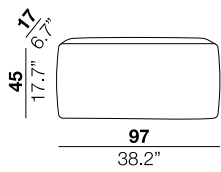

BRQ

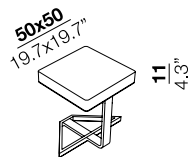

BRR

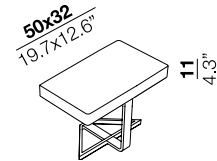

TT

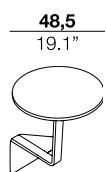

TO

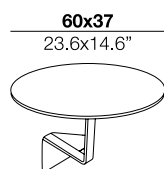

TR

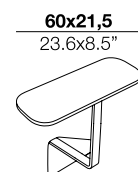

C70

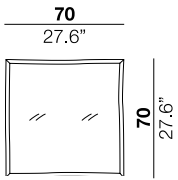

ROL

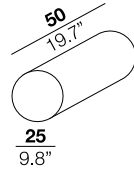

41+21  
SQ3+SQ2

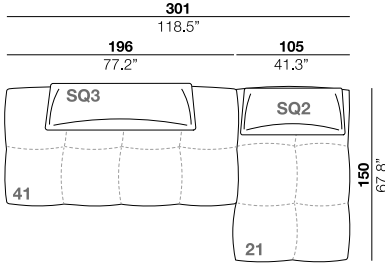

41+51  
SQ4+SQ3

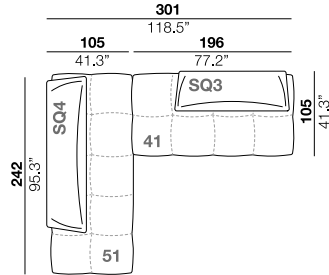

01+01+31  
SQ2+SQ2+SQ3

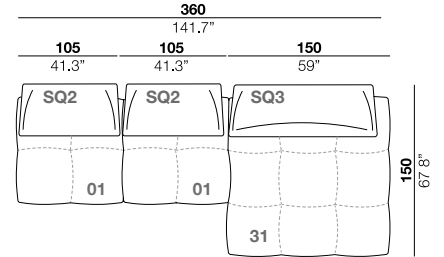

41+41  
SQ7+SQ6(x4)+SK(x6)+ROL+ROL

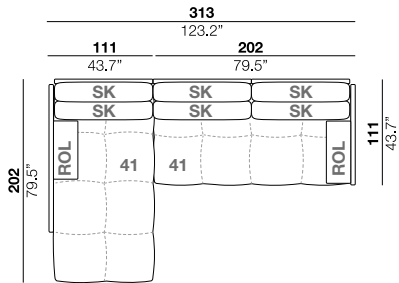

01+01+01  
SQ6(x5)+SK(x6)

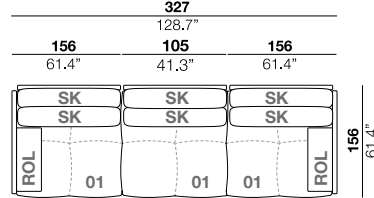

31+21  
SQ7(x2)+SQ6+SK(x4)+ROL

