



## eva II design gianmaria conficconi 2015

Modular sofa with a wooden seat frame supported by elastic belts. The adjustable back cushions and armrests have a metal frame padded with polyurethane foam. The seat cushion is padded with expanded polyurethane foam covered with sterilized hypoallergenic goose-down. The loose lumbar cushions are filled with sterilized hypoallergenic goose-down. Legs are made in shock-absorbing plastic. Note: On demand, the internal side of the armrest is also available with tufting. This option is not available for the swivel armchair (1PG).

Divano modulare con struttura seduta in legno e supporto di nastri elastici. Gli schienali ed i braccioli reclinabili sono in metallo rivestiti in poliuretano espanso. Seduta in poliuretano espanso rivestito con piuma d'oca sterilizzata anallergica. I poggiatesta asportabili sono in piuma d'oca anallergica. I piedi sono in plastica antiurto. Note: Su richiesta, i divani possono essere forniti con l'interno del bracciolo trapuntato come l'esterno della struttura. Questa variante non è disponibile per la poltroncina girevole (1PG).

### seat height

altezza seduta  
43 cm  
16.9"

### seat depth

profondità seduta  
56 cm  
22"

### arm width

larghezza bracciolo  
13/27 cm  
5.1/10.6"

### arm height

altezza bracciolo  
88 cm  
34.6"

### feet height

altezza piede  
2,5 cm  
1"

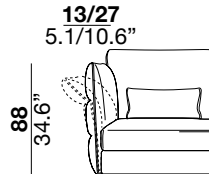
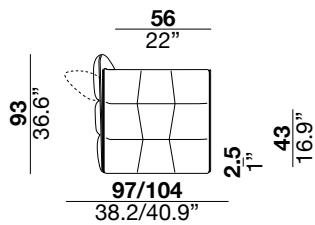

### 1PG swivel armchair

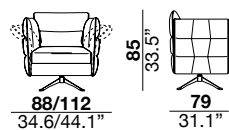

### 1 armchair

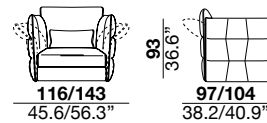

### 2

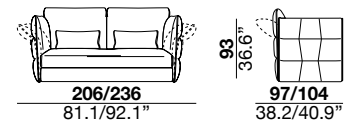

### 3



### X

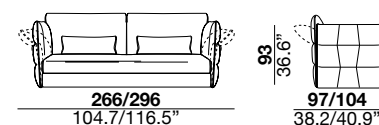

### SX

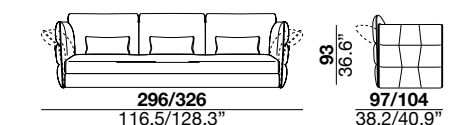

01

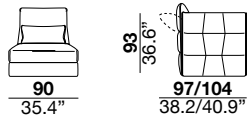

05/06

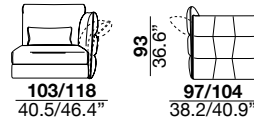

07/08

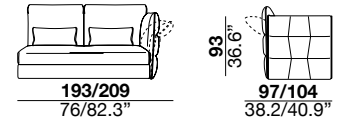
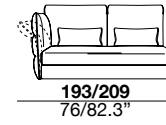

19/20

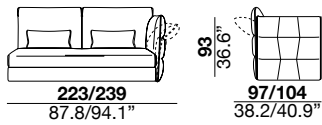
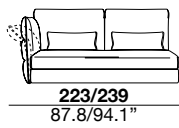

29/30

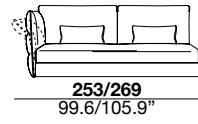

S09/S10

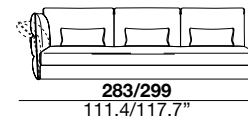

17/18

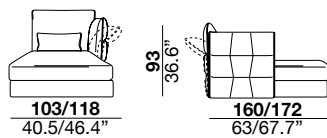
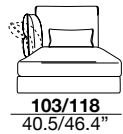

T11/T12

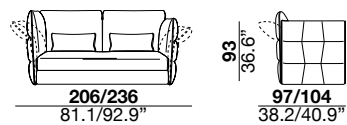
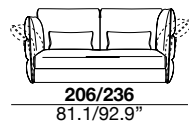

T13/14

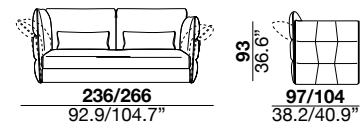
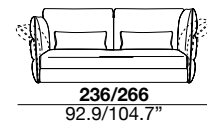

T21/T22

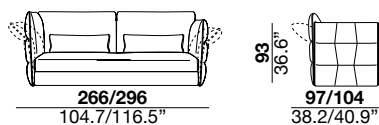
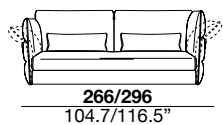

T23/24

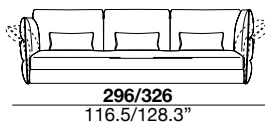

P

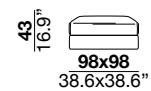

PTP

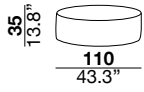

PTG

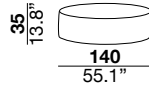

T23+08

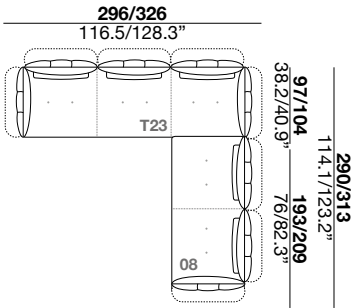

T11+08

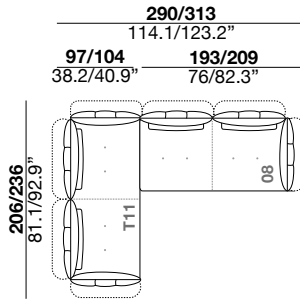

T13+20

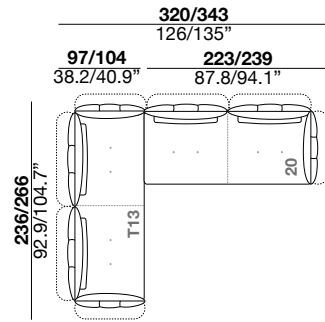

T21+08

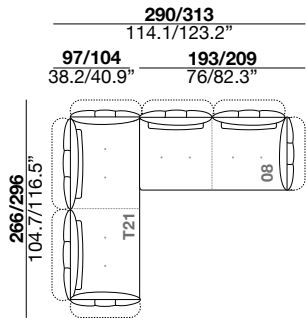

T23+S10

