



## **VICTOR** *DESIGN CENTER 1984*

**SOFAS**

---

## VICTOR | *DESIGN CENTER* | 1984

### SOFA

**Frame** in wood with polyurethane padding covered with a protective fabric lining

**Seat cushions** in sterilized goose down (Assopiuma certified, gold label) with insert in crushproof material or in polyurethane foam and dacron.

Sectional sofas in polyurethane foam and dacron

**Backrest cushions** in sterilized goose down (Assopiuma certified, gold label)

**Optional cushions** in sterilized goose down (Assopiuma certified, gold label). On

request, with upcharge

**Feet** in solid Canaletto walnut with raw-wood effect, natural, or stained walnut extra finish; or in solid ash with natural finish or stained walnut, stained teak, stained wenge, stained brown or stained ebony; or in solid oak with raw-wood effect finish.

**On request** feet in aluminium, with upcharge

**Upholstery** removable fabric or not removable leather covers

COD. 014202

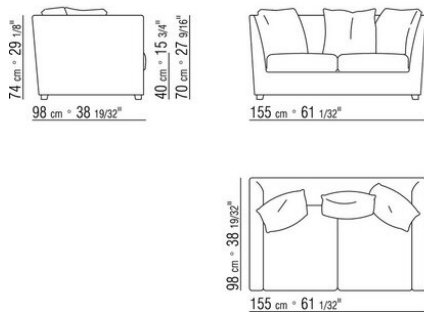

COD. 014208

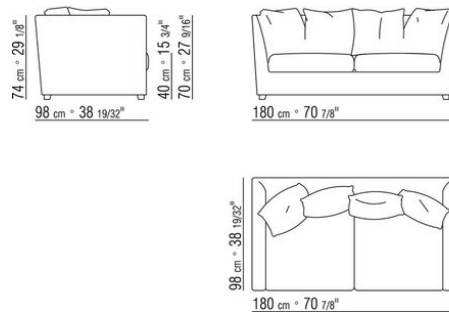

COD. 014203

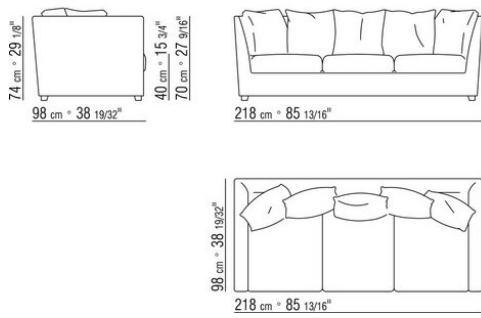

COD. 014204

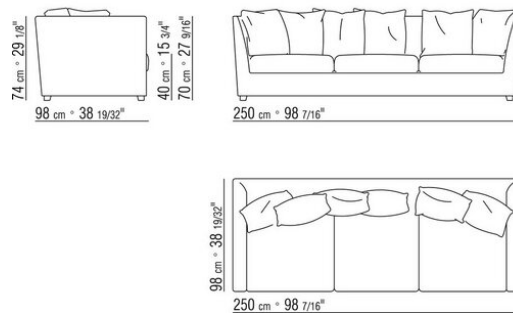

COD. 014212

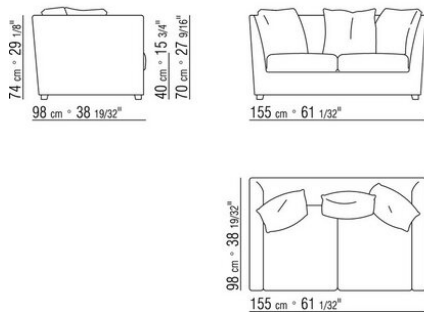

COD. 014218

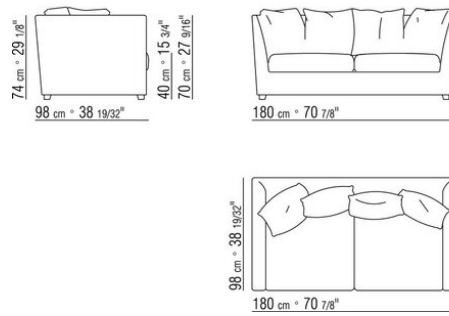

COD. 014213

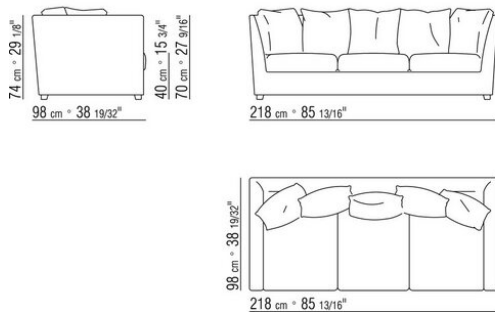

COD. 014214

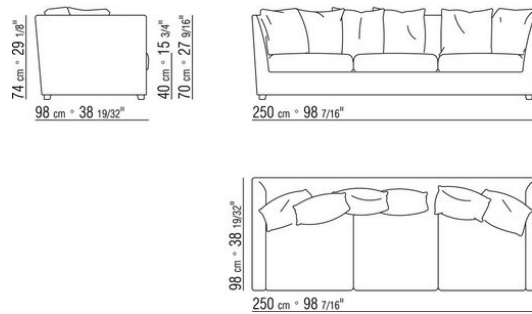

COD. 014250

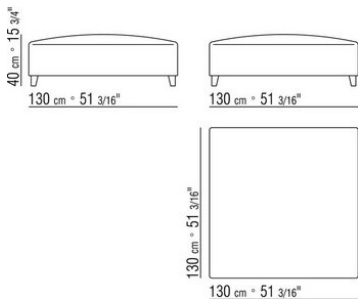

COD. 014251

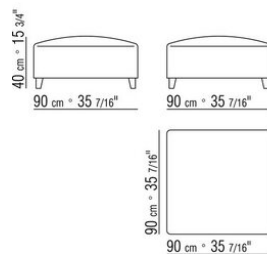

COD. 014252

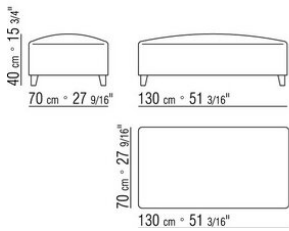

COD. 014260

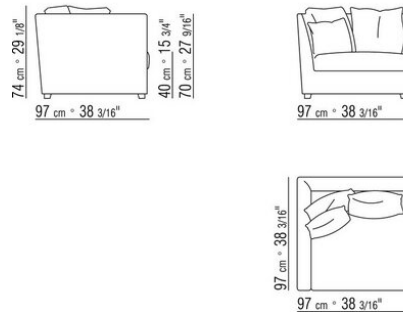

COD. 014263

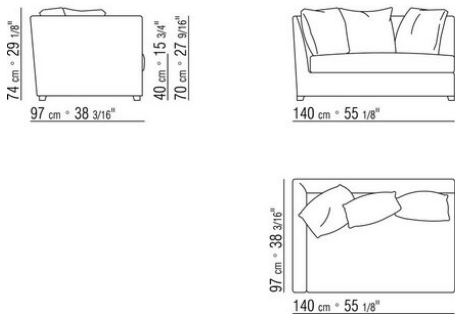

COD. 014265

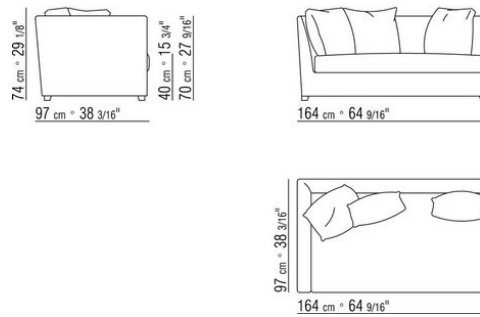

COD. 014267

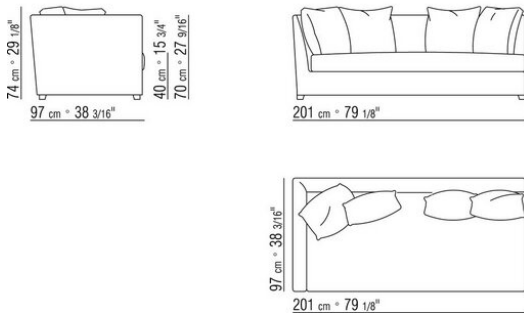

COD. 014269

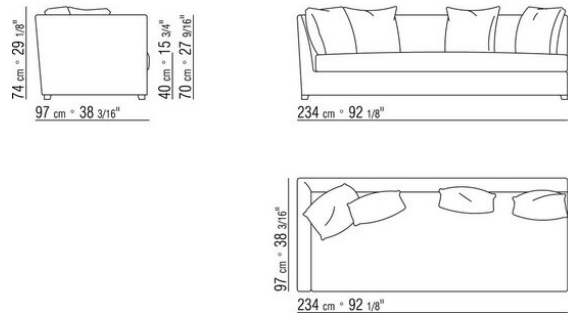

COD. 014273

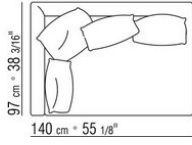
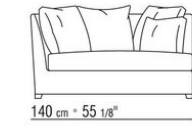
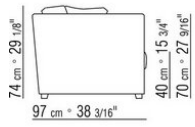

COD. 014275

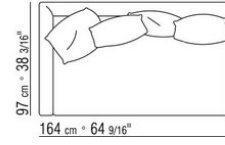
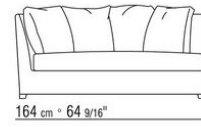
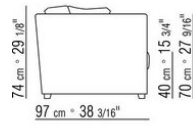

COD. 014277

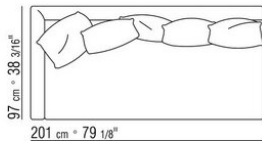
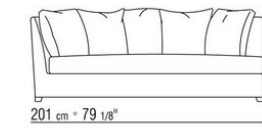
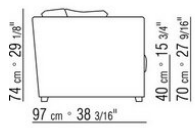

COD. 014279

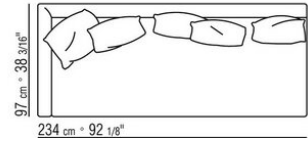
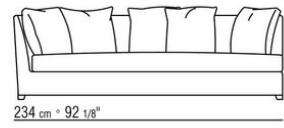
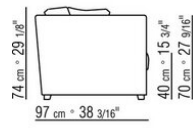

COD. 014299

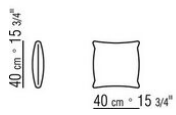

COD. 014298

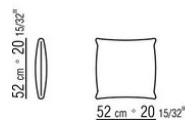

COD. 014297

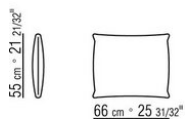

COD. 014290

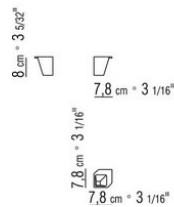

0142XA

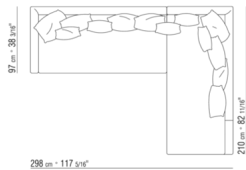

- N.1 COD.014267 - END UNIT L CM.201 x97
- N.1 COD.014221 - DORMEUSE / LONG CORNER L CM.210 x97
- N.5 COD.014299 - CUSHION CM.40 x40

0142XB

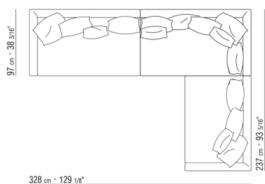

- N.1 COD.014265 - END UNIT L CM.164 x97
- N.1 COD.014274 - CORNER R CM.164 x97
- N.1 COD.014262 - END UNIT R CM.140 x97
- N.5 COD.014299 - CUSHION CM.40 x40