

SOLLER OUTDOOR

STRUTTURA ELEMENTO SINGOLO
SINGLE ELEMENT FRAME

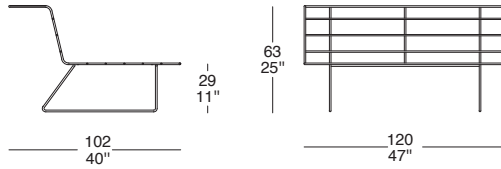

SOL 01

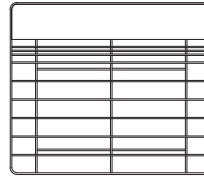

CUSCINO SEDUTA/SCHIENALE EL. SINGOLO
SINGLE EL. SEAT/BACK CUSHION

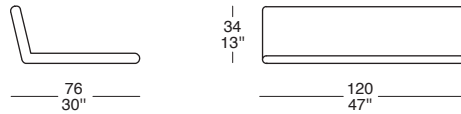

SOL 02



CUSC. SEDUTA/SCHIENALE C/MENSOLA EL. SINGOLO
SINGLE EL. SEAT/BACK CUSH. W/SHELF

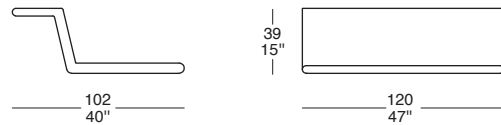

SOL 03

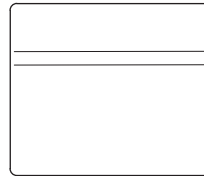

7 ▶

EL. SINGOLO CON CUSCINO SEDUTA/SCHIENALE
SINGLE EL. W/ SINGLE SEAT/BACK CUSHION

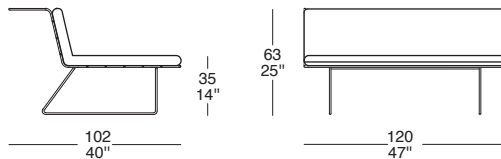

SOL 04

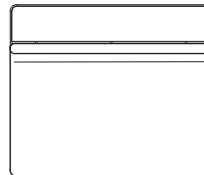

EL. SINGOLO CON CUSC. SEDUTA/SCHIENALE C/MENSOLA
SINGLE EL. W/ SINGLE SEAT/BACK CUSH. W/SHELF

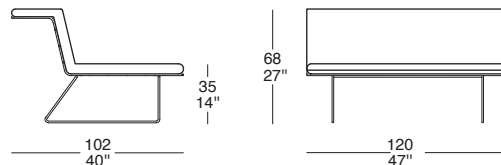

SOL 05

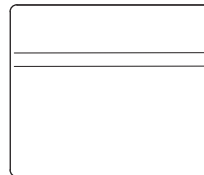

CUSCINI
CUSHIONS
SOL 06

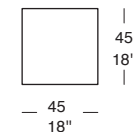

SOL 07

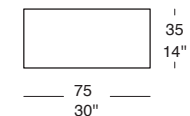

I prodotti della Collezione Outdoor sono stati testati per la collocazione da esterno, l'utilizzo ideale consigliato è per terrazze e verande ed è buona norma proteggere gli articoli da esterno adottando accorgimenti che consentono di migliorarne la durata. È possibile acquistare l'apposito winter set che consente di proteggere meglio dalle intemperie i prodotti acquistati. Preghiamo accertarsi che tutti i prodotti siano completamente asciutti prima di coprirli per evitare accumuli di umidità o la formazione di macchie di muffa.

The products in the Outdoor Collection have been tested so that may be used outside, ideally on terraces and verandas. Outdoor furniture should receive the correct care and maintenance to extend the life of the product.

Il Loft sells the special winter set which enables you to provide the best protection against bad weather for your purchases. Please ensure that all pieces of furniture are completely dry before covering them to prevent damp patches or the formation of mould stains.

SOLLER OUTDOOR

STRUTTURA ANGOLO
CORNER ELEMENT FRAME

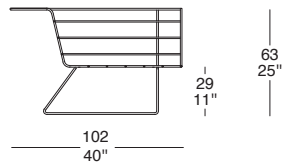

SOL 08

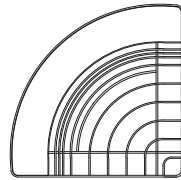

CUSCINO SEDUTA/SCHIENALE ANGOLO
CORNER SEAT/BACK CUSHION

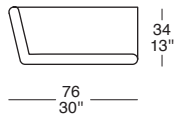

SOL 09

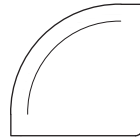

CUSC. SEDUTA/SCHIENALE C/MENSOLA ANGOLO
CORNER SEAT/BACK CUSH. W/SHELF

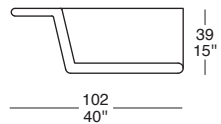

SOL 10

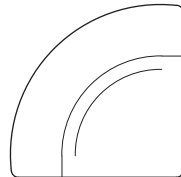

ANGOLO CON CUSCINO SEDUTA/SCHIENALE
CORNER W/SEAT/BACK CUSHION

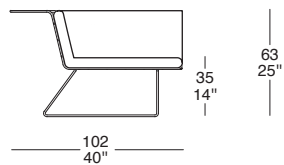

SOL 11



ANGOLO C/CUSC. SEDUTA/SCHIENALE C/MENSOLA
ANGOLO W/SEAT/BACK CUSH/SHELF

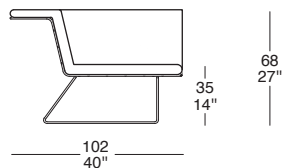

SOL 12

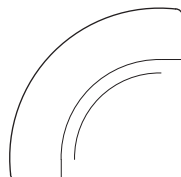

I prodotti della Collezione Outdoor sono stati testati per la collocazione da esterno, l'utilizzo ideale consigliato è per terrazzi e verande ed è buona norma proteggere gli articoli da esterno adottando accorgimenti che consentono di migliorarne la durata.

È possibile acquistare l'apposito winter set che consente di proteggere meglio dalle intemperie i prodotti acquistati. Preghiamo accertarsi che tutti i prodotti siano completamente asciutti prima di coprirli per evitare accumuli di umidità o la formazione di macchie di muffa.

The products in the Outdoor Collection have been tested so that may be used outside, ideally on terraces and verandas. Outdoor furniture should receive the correct care and maintenance to extend the life of the product. Il Loft sells the special winter set which enables you to provide the best protection against bad weather for your purchases. Please ensure that all pieces of furniture are completely dry before covering them to prevent damp patches or the formation of mould stains.

SOLLER OUTDOOR

STRUTTURA POUFF OTTOMAN FRAME

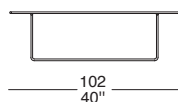
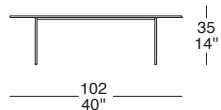

SOL 13

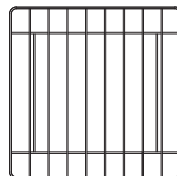

CUSCINO POUFF OTTOMAN SEAT CUSHION

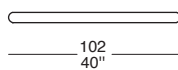
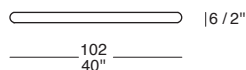

SOL 14

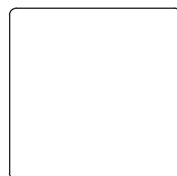

POUFF CON CUSCINO OTTOMAN WITH CUSHION

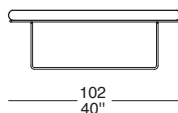
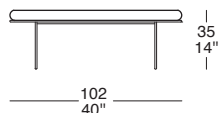

SOL 15

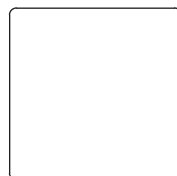

I prodotti della Collezione Outdoor sono stati testati per la collocazione da esterno, l'utilizzo ideale consigliato è per terrazzi e verande ed è buona norma proteggere gli articoli da esterno adottando accorgimenti che consentono di migliorarne la durata.

È possibile acquistare l'apposito winter set che consente di proteggere meglio dalle intemperie i prodotti acquistati. Preghiamo accertarsi che tutti i prodotti siano completamente asciutti prima di coprirli per evitare accumuli di umidità o la formazione di macchie di muffa.

The products in the Outdoor Collection have been tested so that may be used outside, ideally on terraces and verandas. Outdoor furniture should receive the correct care and maintenance to extend the life of the product. Il Loft sells the special winter set which enables you to provide the best protection against bad weather for your purchases. Please ensure that all pieces of furniture are completely dry before covering them to prevent damp patches or the formation of mould stains.

SOLLER OUTDOOR

STRUTTURA CHAISE LONGUE
CHAISE LONGUE FRAME

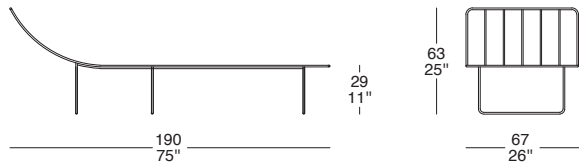

SOL 16

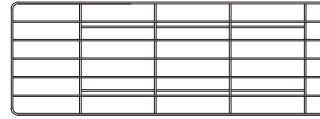

CUSCINO CHAISE LONGUE
CHAISE LONGUE SEAT CUSHION

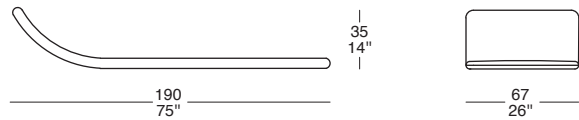

SOL 17



CHAISE LONGUE CON CUSCINO
CHAISE LONGUE WITH CUSHION

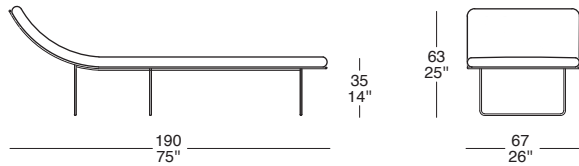

SOL 18



I prodotti della Collezione Outdoor sono stati testati per la collocazione da esterno, l'utilizzo ideale consigliato è per terrazze e verande ed è buona norma proteggere gli articoli da esterno adottando accorgimenti che consentono di migliorarne la durata.

È possibile acquistare l'apposito winter set che consente di proteggere meglio dalle intemperie i prodotti acquistati. Preghiamo accertarsi che tutti i prodotti siano completamente asciutti prima di coprirli per evitare accumuli di umidità o la formazione di macchie di muffa.

The products in the Outdoor Collection have been tested so that may be used outside, ideally on terraces and verandas. Outdoor furniture should receive the correct care and maintenance to extend the life of the product. Il Loft sells the special winter set which enables you to provide the best protection against bad weather for your purchases. Please ensure that all pieces of furniture are completely dry before covering them to prevent damp patches or the formation of mould stains.

SOLLER OUTDOOR

STRUTTURA CHAISE LONGUE
CHAISE LONGUE FRAME

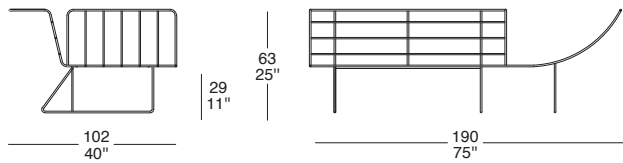

SOL 19
SX

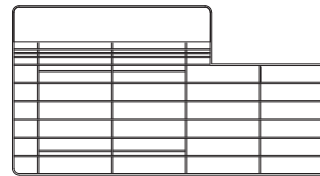

SOL 24
DX

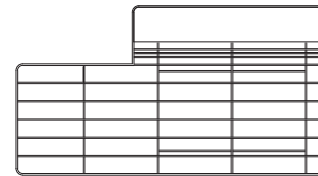

CUSCINO SEDUTA/SCHIENALE CHAISE LONGUE
CHAISE LONGUE SEAT/BACK CUSHION

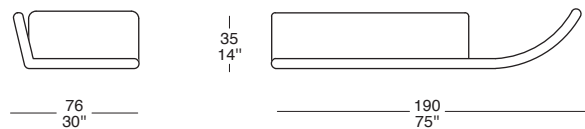

SOL 20
SX

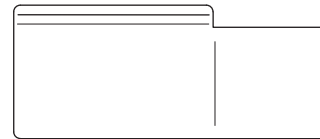

SOL 25
DX

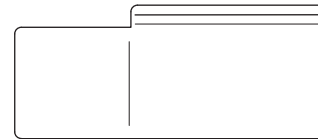

CUSCINO SEDUTA/SCHIENALE C/ MENSOLA CHAISE LONGUE
CHAISE LONGUE SEAT/BACK/SHELF CUSHION

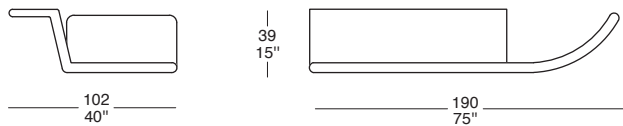

SOL 21
SX

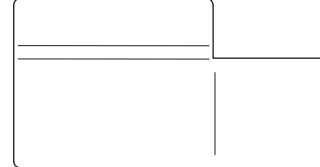

SOL 26
DX

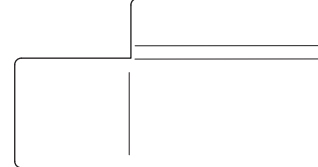

CHAISE LONGUE CON CUSCINO SEDUTA/SCHIENALE
CHAISE LONGUE WITH SEAT/BACK CUSHION

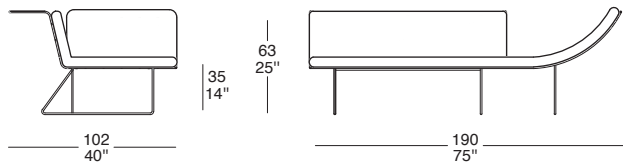

SOL 22
SX

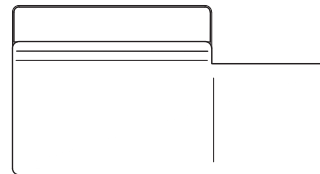

SOL 27
DX

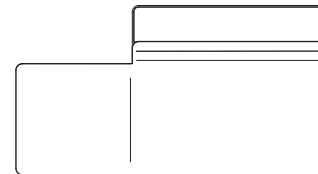

CHAISE LONGUE CON CUSCINO SEDUTA/SCHIENALE C/MENSOLA
CHAISE LONGUE WITH SEAT/BACK/SHELF CUSHION

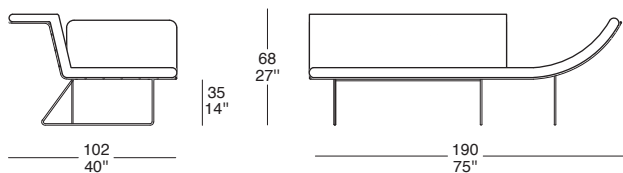

SOL 23
SX

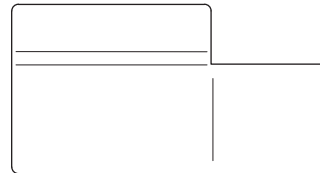

SOL 28
DX

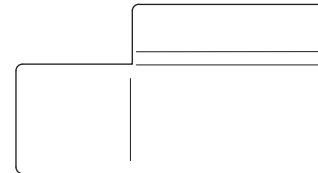

I prodotti della Collezione Outdoor sono stati testati per la collocazione da esterno, l'utilizzo ideale consigliato è per terrazze e verande ed è buona norma proteggere gli articoli da esterno adottando accorgimenti che consentono di migliorarne la durata.

È possibile acquistare l'apposito winter set che consente di proteggere meglio dalle intemperie i prodotti acquistati. Preghiamo accertarsi che tutti i prodotti siano completamente asciutti prima di coprirli per evitare accumuli di umidità o la formazione di macchie di muffa.

The products in the Outdoor Collection have been tested so that may be used outside, ideally on terraces and verandas. Outdoor furniture should receive the correct care and maintenance to extend the life of the product. Il Loft sells the special winter set which enables you to provide the best protection against bad weather for your purchases. Please ensure that all pieces of furniture are completely dry before covering them to prevent damp patches or the formation of mould stains.

SOLLER OUTDOOR

STRUTTURA ELEMENTO SPICCHIO
SPICCHIO ELEMENT FRAME

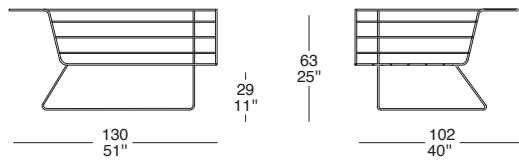

SOL 29
SX

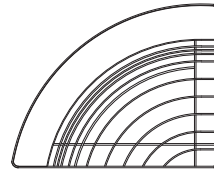

SOL 34
DX

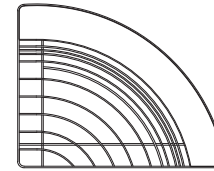

CUSC.SEDUTA/SCHIENALE SPICCHIO
SPICCHIO SEAT/BACK CUSHION

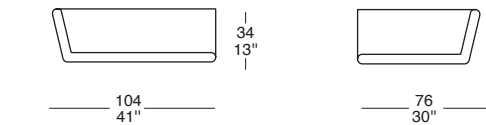

SOL 30
SX

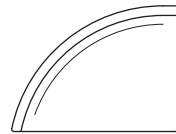

SOL 35
DX

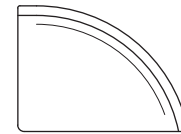

CUSC.SEDUTA/SCHIENALE C.MENSOLA SPICCHIO
SPICCHIO SEAT/BACK/SHELF CUSHION

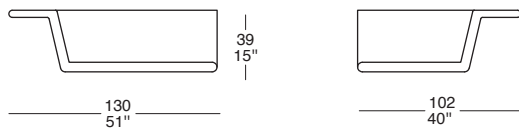

SOL 31
SX

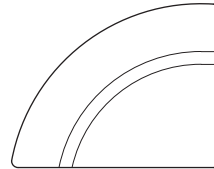

SOL 36
DX

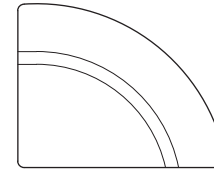

EL. SPICCHIO CON CUSCINO SEDUTA/SCHIENALE
SPICCHIO EL. WITH SEAT/BACK CUSHION

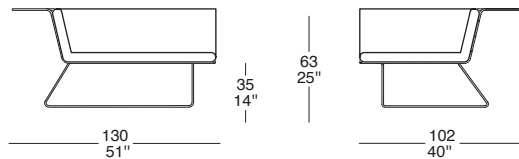

SOL 32
SX



SOL 37
DX



EL. SPICCHIO CON CUSC.SEDUTA/SCHIENALE C/MENSOLA
SPICCHIO EL. W/SEAT/BACK CUSH. W/SHELF

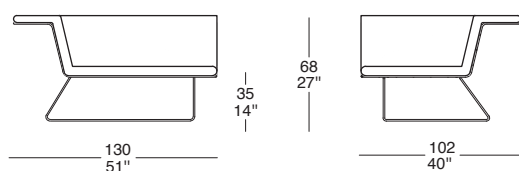

SOL 33
SX

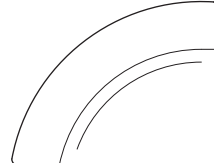

SOL 38
DX

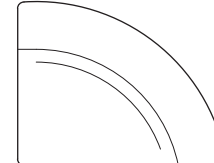

I prodotti della Collezione Outdoor sono stati testati per la collocazione da esterno, l'utilizzo ideale consigliato è per terrazzi e verande ed è buona norma proteggere gli articoli da esterno adottando accorgimenti che consentono di migliorarne la durata.

È possibile acquistare l'apposito winter set che consente di proteggere meglio dalle intemperie i prodotti acquistati. Preghiamo accertarsi che tutti i prodotti siano completamente asciutti prima di coprirli per evitare accumuli di umidità o la formazione di macchie di muffa.

The products in the Outdoor Collection have been tested so that may be used outside, ideally on terraces and verandas. Outdoor furniture should receive the correct care and maintenance to extend the life of the product. Il Loft sells the special winter set which enables you to provide the best protection against bad weather for your purchases. Please ensure that all pieces of furniture are completely dry before covering them to prevent damp patches or the formation of mould stains.

SOLLER OUTDOOR

COMP SPICCHIO C/CUSCINO SEDUTA
SPICCHIO GROUP W/SEAT/BACK CUSHION

SOL 39

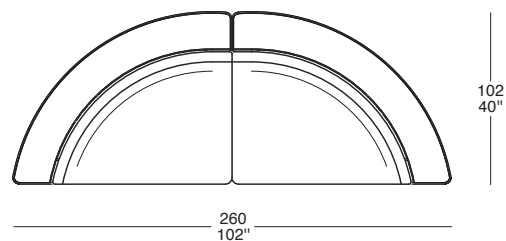

COMP SPICCHIO C/CUSCINO SEDUTA CON MENSOLA
SPICCHIO GROUP W/SEAT/BACK/SHELF CUSHION

SOL 40

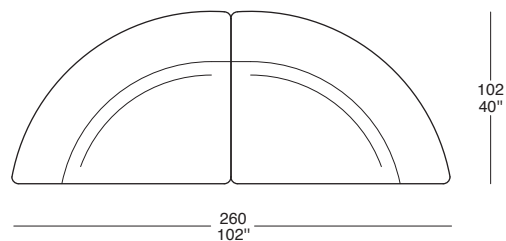

13 ►

I prodotti della Collezione Outdoor sono stati testati per la collocazione da esterno, l'utilizzo ideale consigliato è per terrazzi e verande ed è buona norma proteggere gli articoli da esterno adottando accorgimenti che consentono di migliorarne la durata.

È possibile acquistare l'apposito winter set che consente di proteggere meglio dalle intemperie i prodotti acquistati. Preghiamo accertarsi che tutti i prodotti siano completamente asciutti prima di coprirli per evitare accumuli di umidità o la formazione di macchie di muffa.

The products in the Outdoor Collection have been tested so that may be used outside, ideally on terraces and verandas. Outdoor furniture should receive the correct care and maintenance to extend the life of the product. Il Loft sells the special winter set which enables you to provide the best protection against bad weather for your purchases. Please ensure that all pieces of furniture are completely dry before covering them to prevent damp patches or the formation of mould stains.

SOLLER OUTDOOR

STRUTTURA ELEMENTO ROTONDO
ROUND ELEMENT FRAME

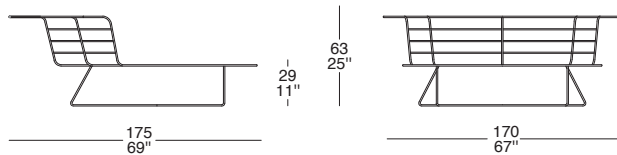

SOL 41

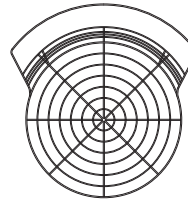

CUSC.SEDUTA/SCHIENALE ELEMENTO ROTONDO
ROUND SEAT/BACK CUSHION

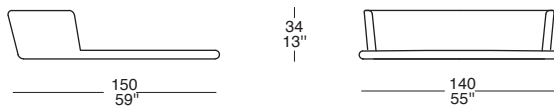

SOL 42

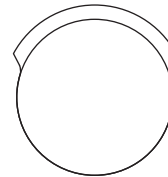

CUSC.SEDUTA/SCHIENALE C.MENSOLA ROTONDO
ROUND SEAT/BACK/SHELF CUSHION

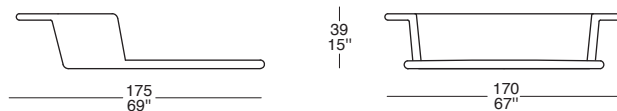

SOL 43

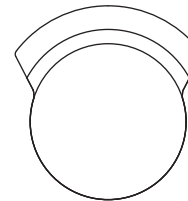

EL. ROTONDO CON CUSCINO SEDUTA/SCHIENALE
ROUND EL. WITH SEAT/BACK CUSHION

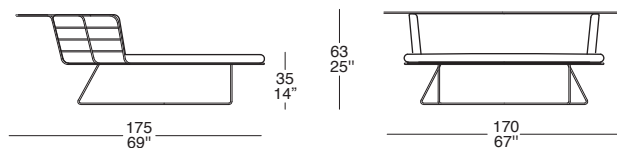

SOL 44

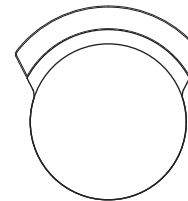

EL. ROTONDO CON CUSC.SEDUTA/SCHIENALE C/MENSOLA
ROUND EL. W/SEAT/BACK CUSH. W/SHELF

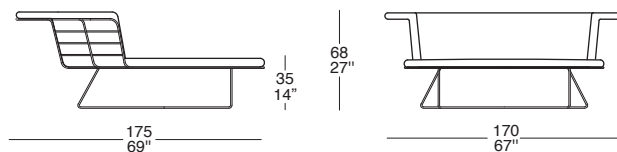

SOL 45

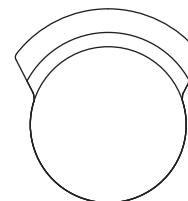

I prodotti della Collezione Outdoor sono stati testati per la collocazione da esterno, l'utilizzo ideale consigliato è per terrazzi e verande ed è buona norma proteggere gli articoli da esterno adottando accorgimenti che consentono di migliorarne la durata.

È possibile acquistare l'apposito winter set che consente di proteggere meglio dalle intemperie i prodotti acquistati. Preghiamo accertarsi che tutti i prodotti siano completamente asciutti prima di coprirli per evitare accumuli di umidità o la formazione di macchie di muffa.

The products in the Outdoor Collection have been tested so that may be used outside, ideally on terraces and verandas. Outdoor furniture should receive the correct care and maintenance to extend the life of the product. Il Loft sells the special winter set which enables you to provide the best protection against bad weather for your purchases. Please ensure that all pieces of furniture are completely dry before covering them to prevent damp patches or the formation of mould stains.

SOLLER OUTDOOR

COMP C/CUSCINO SEDUTA/SCHIENALE
GROUP W/SEAT/BACK CUSHION

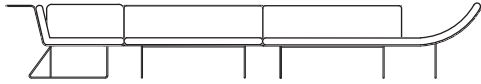

SOL 46

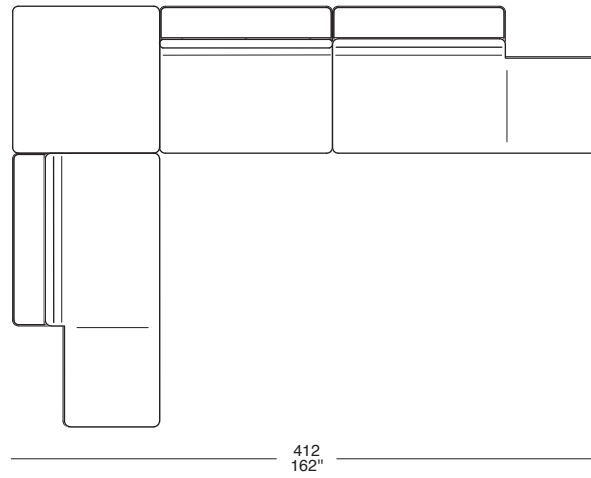

SOL 47

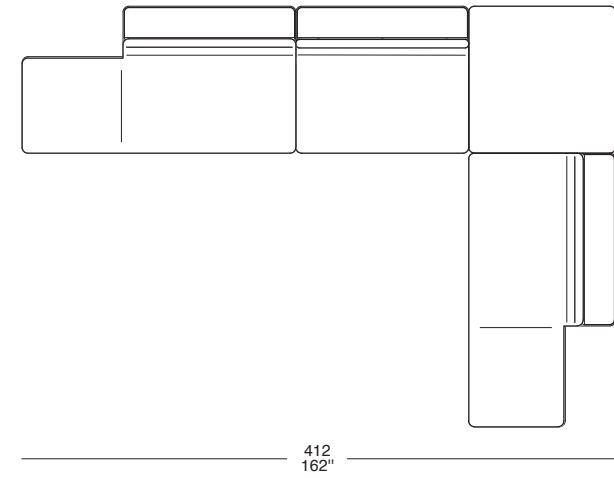

15 ▶

COMP C/CUSCINO SEDUTA/SCHIENALE C. MENSOLA
GROUP W/SEAT/BACK/SHELF CUSHION

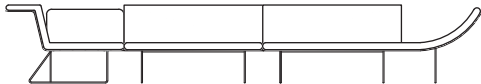

SOL 48

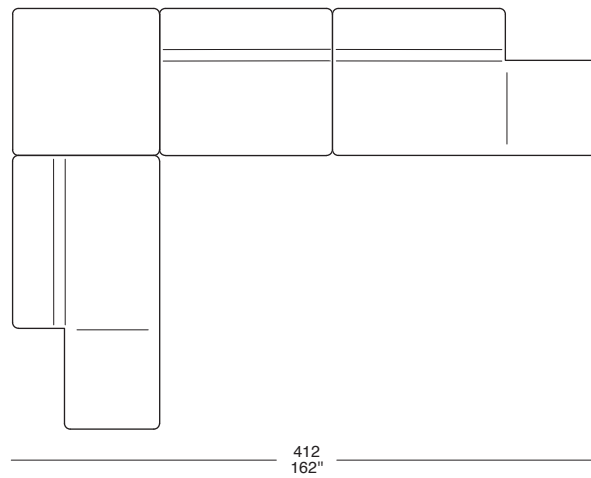

SOL 49

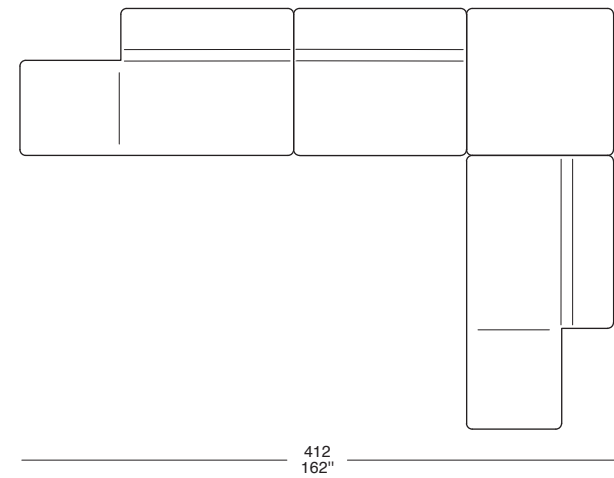

SOLLER OUTDOOR

COMP C/CUSCINO SEDUTA/SCHIENALE
GROUP W/SEAT/BACK CUSHION

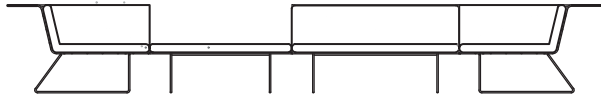

SOL 50

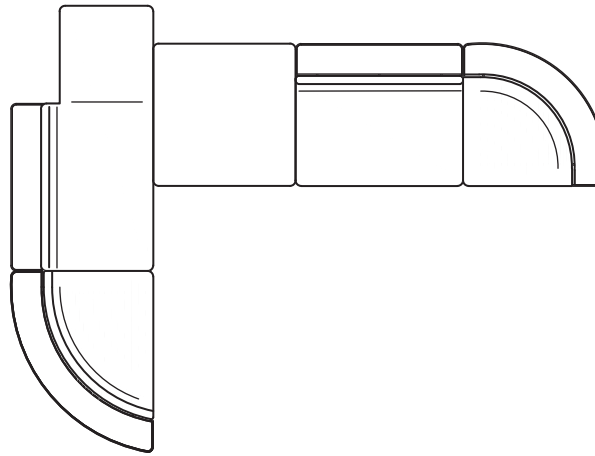

426
168"

SOL 51

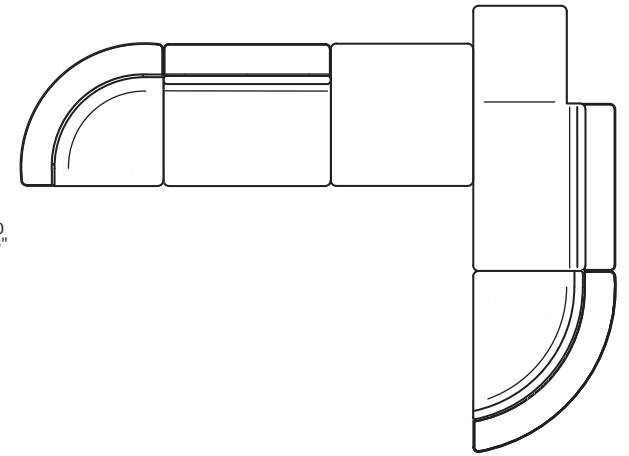

426
168"

320
126"

16 ▶

COMP C/CUSCINO SEDUTA/SCHIENALE C. MENSOLA
GROUP W/SEAT/BACK/SHELF CUSHION

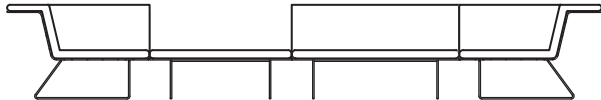

SOL 52

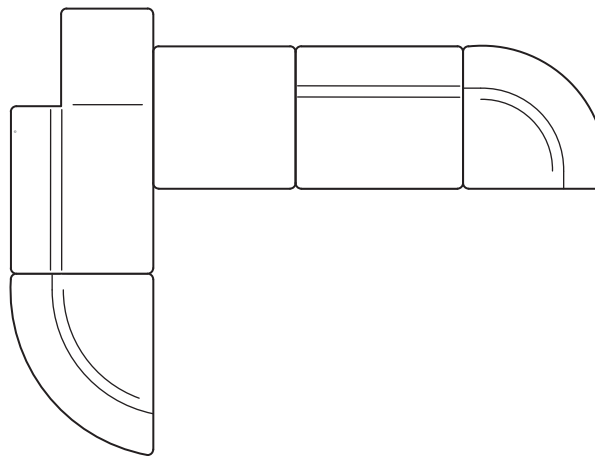

426
168"

SOL 53

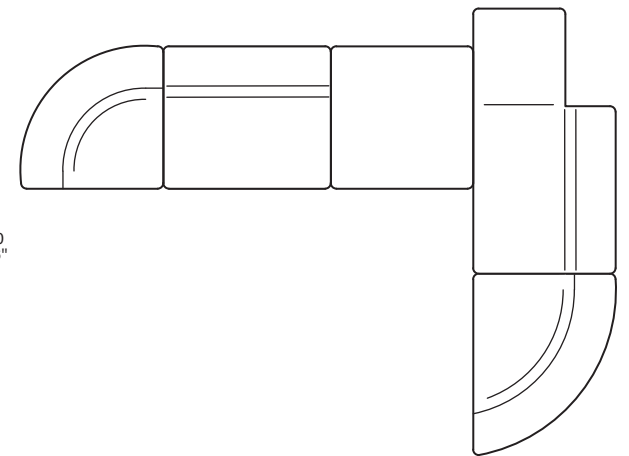

426
168"

320
126"

SOLLER OUTDOOR

COMP C/CUSCINO SEDUTA/SCHIENALE
GROUP W/SEAT/BACK CUSHION



SOL 54

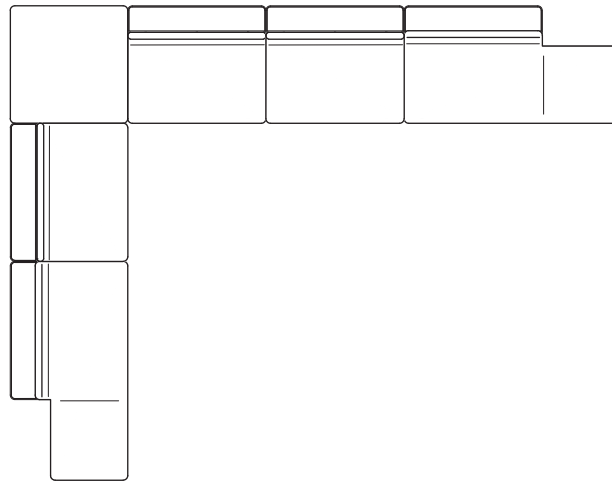

532
209"

SOL 55



412
162"

532
209"

17 ►

COMP C/CUSCINO SEDUTA/SCHIENALE C. MENSOLA
GROUP W/SEAT/BACK/SHELF CUSHION



SOL 56

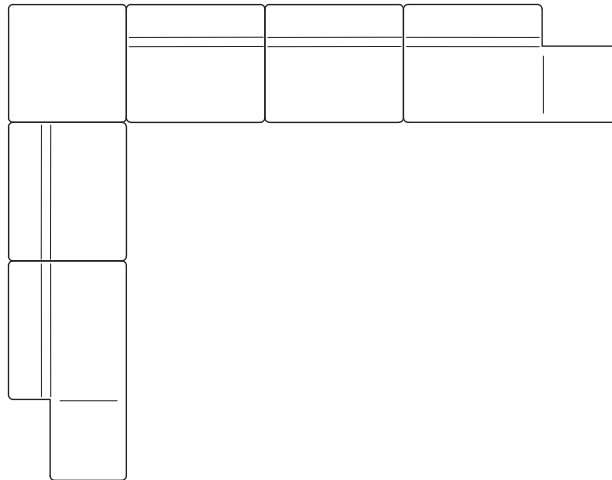

532
209"

SOL 57

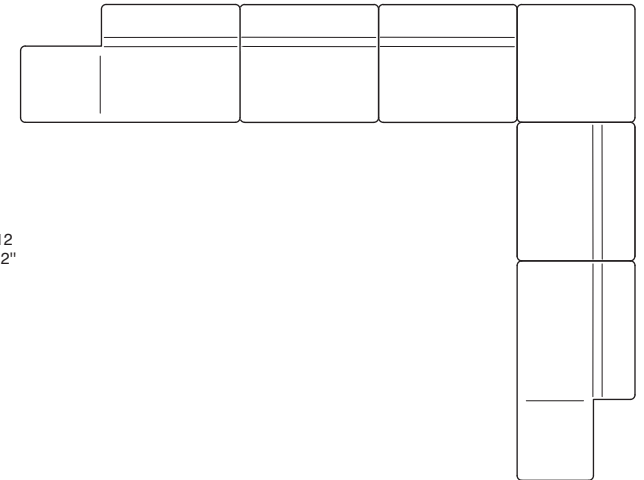

412
162"

532
209"

SOLLER OUTDOOR

COMP C/CUSCINO SEDUTA/SCHIENALE
GROUP W/SEAT/BACK CUSHION

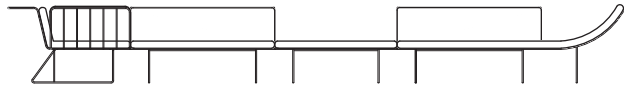

SOL 58

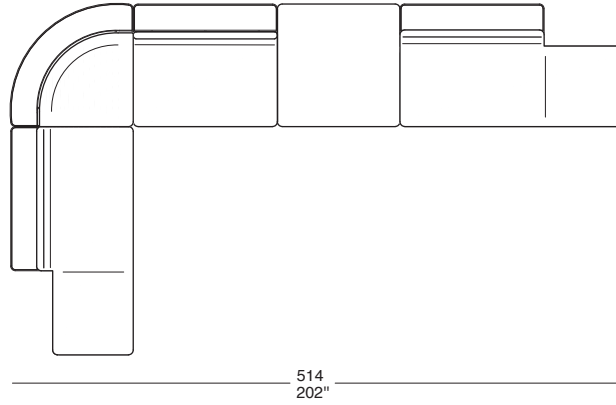

SOL 59

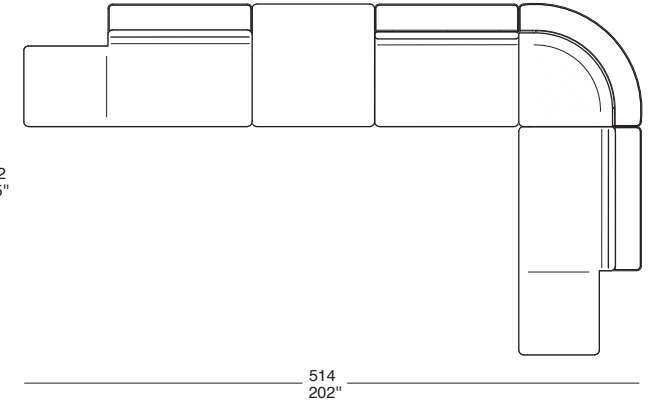

18 ►

COMP C/CUSCINO SEDUTA/SCHIENALE C. MENSOLA
GROUP W/SEAT/BACK/SHELF CUSHION

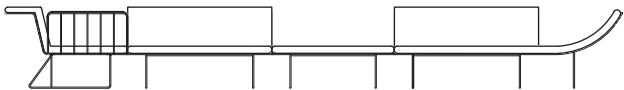

SOL 60

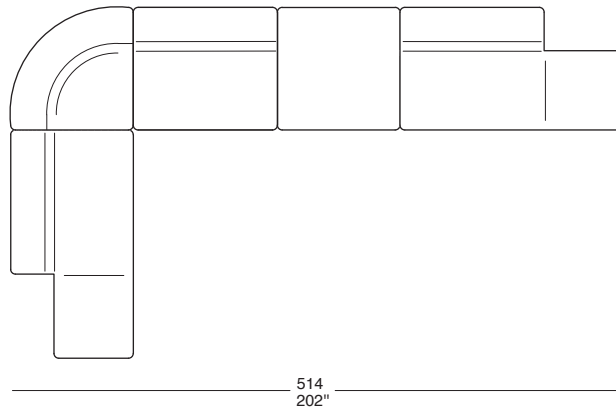

SOL 61

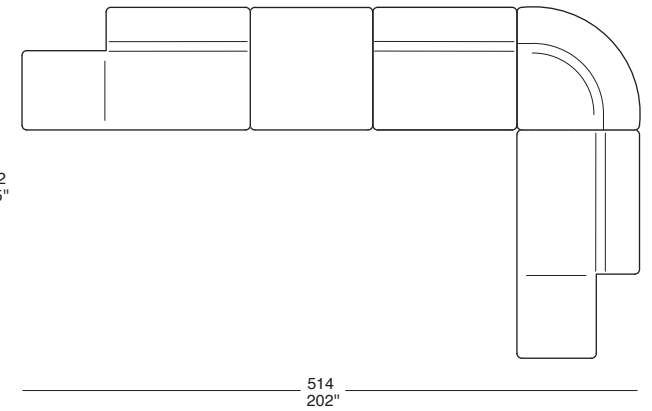

SOLLER OUTDOOR TAVOLINO

TAVOLINO
LOW TABLE

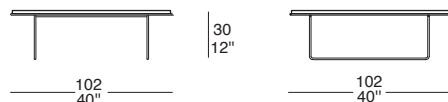

SOL 80

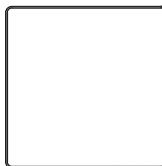

I prodotti della Collezione Outdoor sono stati testati per la collocazione da esterno, l'utilizzo ideale consigliato è per terrazzi e verande ed è buona norma proteggere gli articoli da esterno adottando accorgimenti che consentono di migliorarne la durata.

È possibile acquistare l'apposito winter set che consente di proteggere meglio dalle intemperie i prodotti acquistati. Preghiamo accertarsi che tutti i prodotti siano completamente asciutti prima di coprirli per evitare accumuli di umidità o la formazione di macchie di muffa.

The products in the Outdoor Collection have been tested so that may be used outside, ideally on terraces and verandas. Outdoor furniture should receive the correct care and maintenance to extend the life of the product. Il Loft sells the special winter set which enables you to provide the best protection against bad weather for your purchases. Please ensure that all pieces of furniture are completely dry before covering them to prevent damp patches or the formation of mould stains.

19 ►

TAVOLINO
LOW TABLE

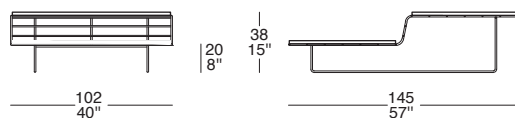

SOL 81

