

FLEXFORM



LONG ISLAND 05 *DESIGN CENTER 2005*

SOFAS

FLEXFORM Spa

Via Einaudi 23/25 20821 Meda (MB) Italy | Tel. +39 0362 3991 | info@flexform.it | www.flexform.it

LONG ISLAND 05 | *DESIGN CENTER* | 2005

Structure in solid wood with polyurethane foam padding, covered with a protective laminated fabric

Seat cushions in sterilized goose down (Assopiuma certified, gold label) with insert in crushproof material or in polyurethane foam and dacron

Backrest cushions in sterilized goose down (Assopiuma certified, gold label) and fiber

Optional cushions in sterilized goose down (Assopiuma certified, gold label). Optional cushions are upon request, with upcharge

Feet hidden feet

Base 24 in metal in satin, chrome, black chrome, burnished, glossy anthracite or matt titanium 710 finish

Upholstery removable fabric or not removable leather covers

FIT-IN BACKREST / SERVICE TABLE

Cushion in sterilized goose down (Assopiuma certified, gold label) with polyurethane foam support bolster. The optional cushion with bolster is upon request, with upcharge

Frame in metal covered with hide leather: russian red 5008, olive 5006, black 5005, dark brown 5004, dark brown extra 5013, grey 5003, sand 5001, tobacco 5015. Also available in black suede 6005, dark brown suede 6004, olive suede 6003, sand suede 6001

COD. 012V02

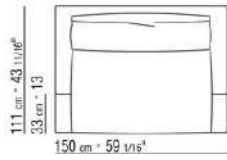
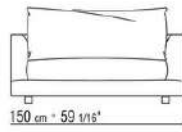
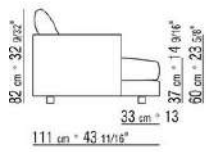

COD. 012V08

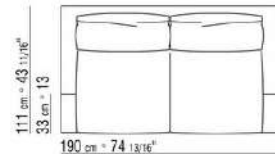
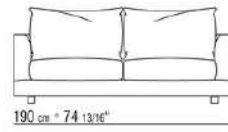
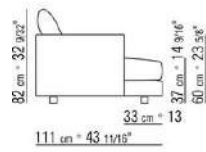

COD. 012V03

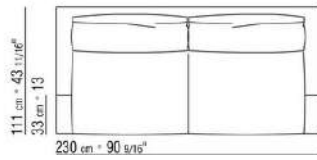
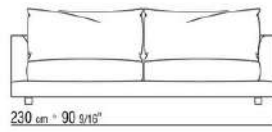
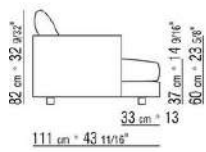

COD. 012V04

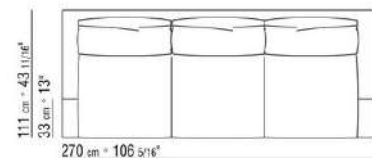
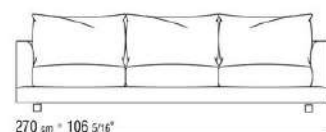
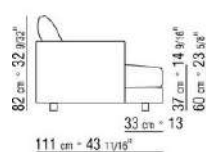

COD. 012V12

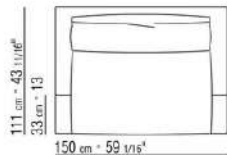
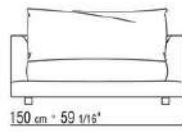
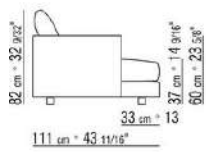

COD. 012V18

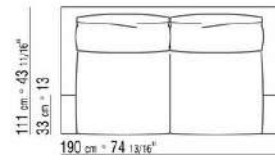
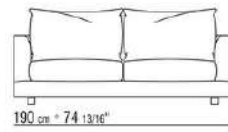
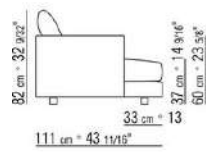

COD. 012V13

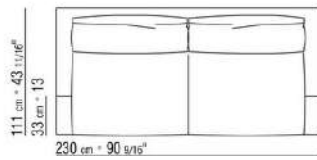
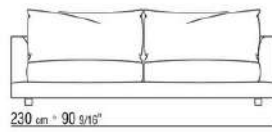
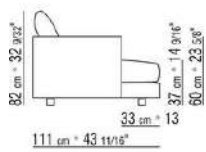

COD. 012V14

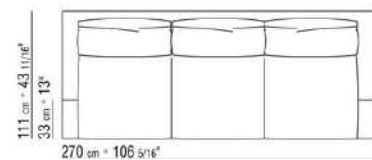
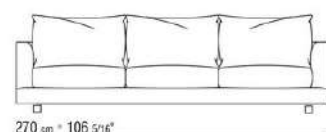
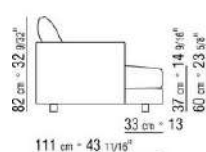

COD. 012V51

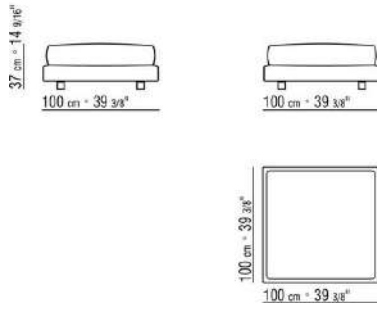

COD. 012V50

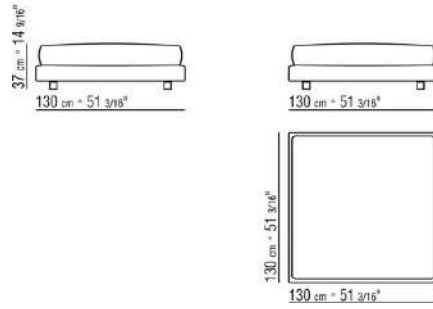

COD. 012V53

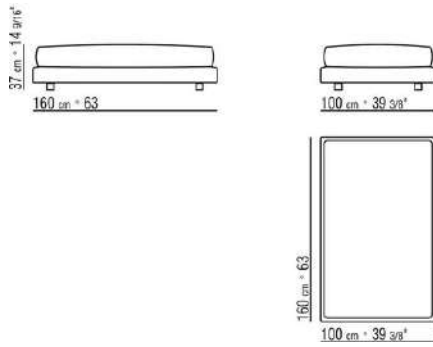

COD. 012V61

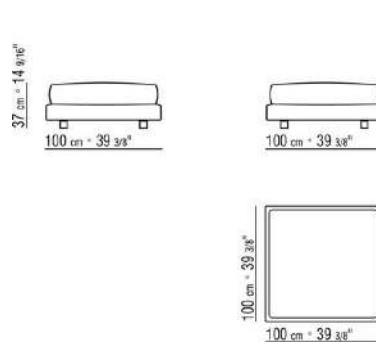

COD. 012V60

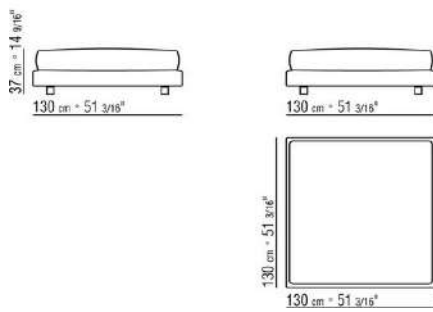

COD. 012V63

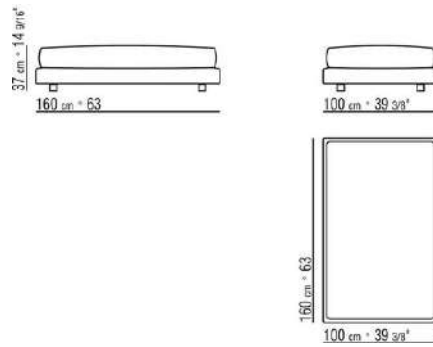

COD. 012V23

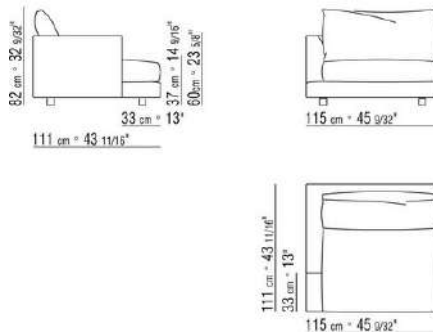

COD. 012V25

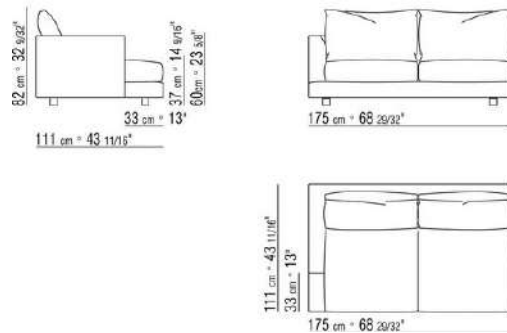

COD. 012V27

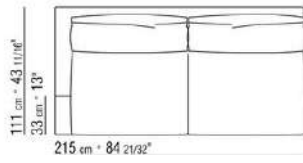
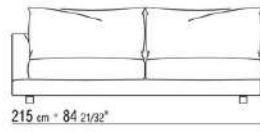
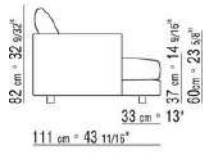

COD. 012V28

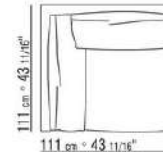
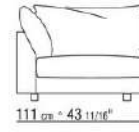

COD. 012V21

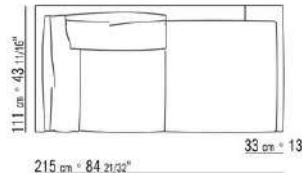
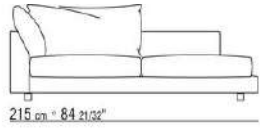
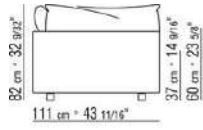

COD. 012V33

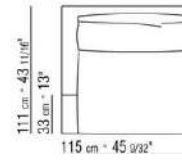
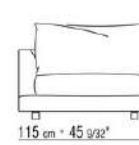
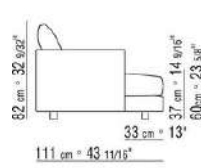

COD. 012V35

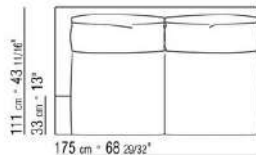
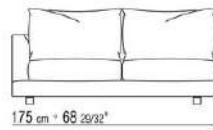
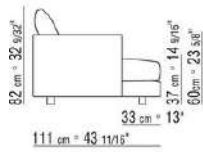

COD. 012V37

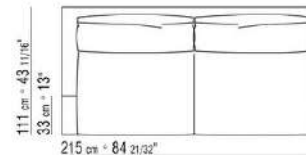
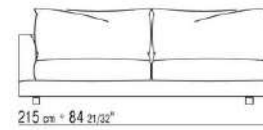
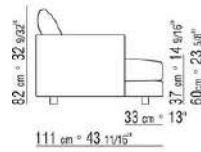

COD. 012V38

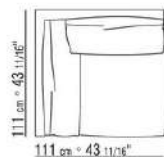
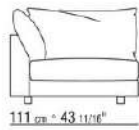
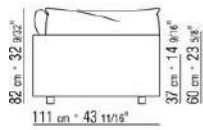

COD. 012V31

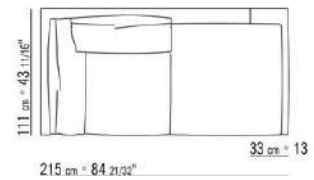
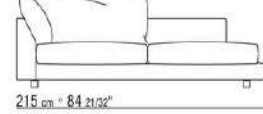
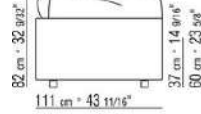

COD. 012V96

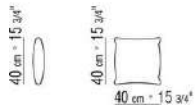

COD. 012V97

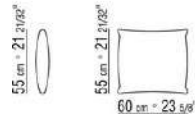

COD. 012V99

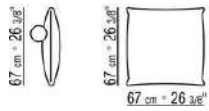

COD. 012V80

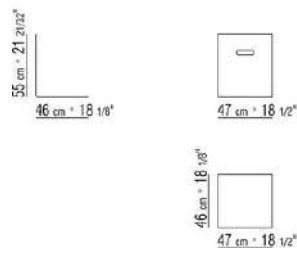

COD. 012V71

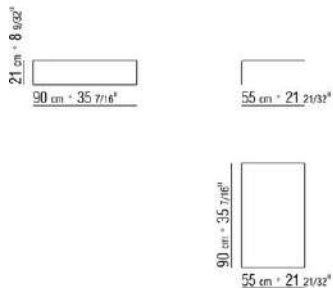

COD. 012V70

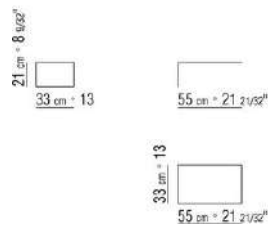

COD. 02D202

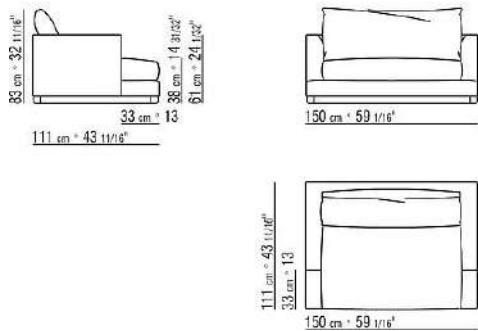

COD. 02D203

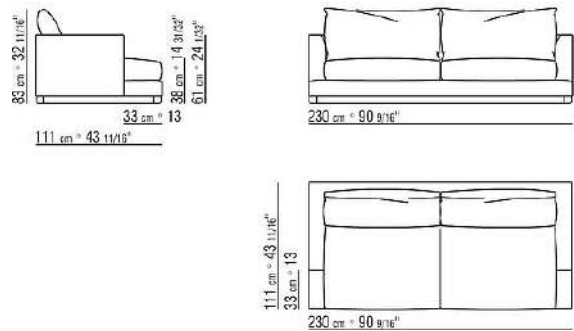

COD. 02D204

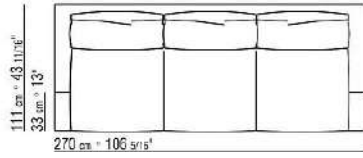
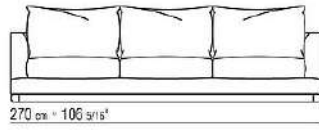
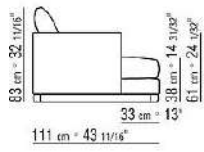

COD. 02D208

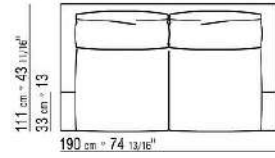
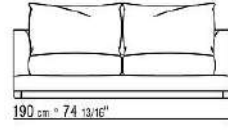
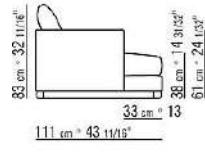

COD. 02D212

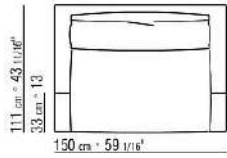
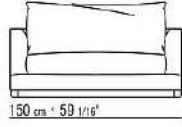
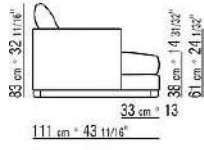

COD. 02D213

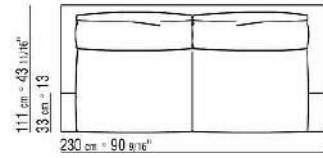
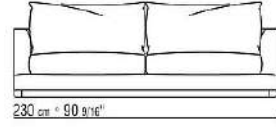
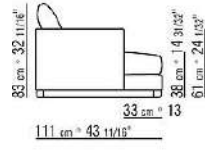

COD. 02D214

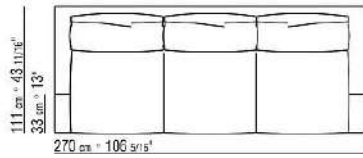
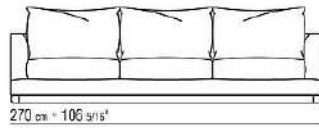
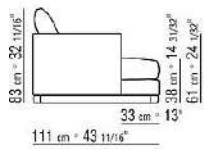

COD. 02D218

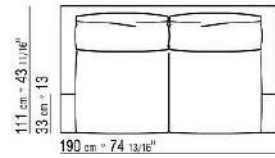
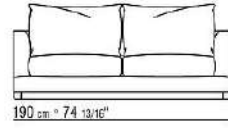
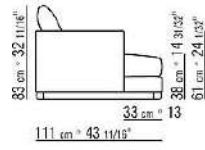

COD. 02D221

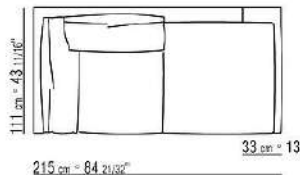
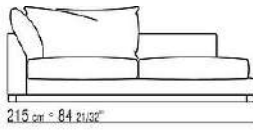
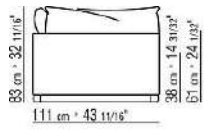

COD. 02D223

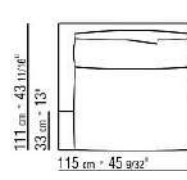
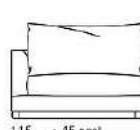
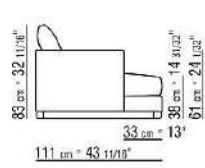

COD. 02D225

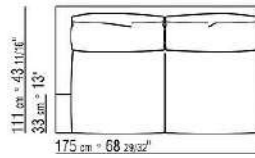
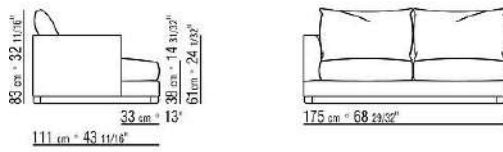

COD. 02D227

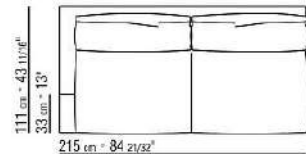
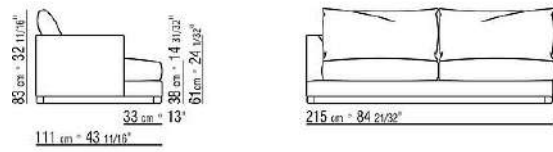

COD. 02D228

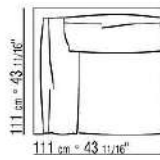
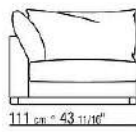
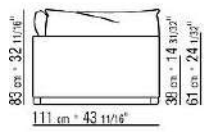

COD. 02D231

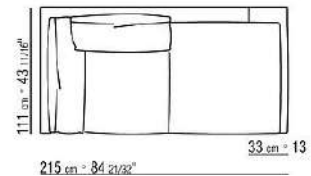
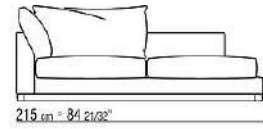

COD. 02D233

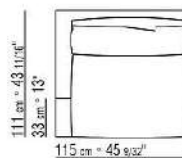
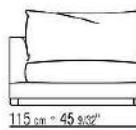
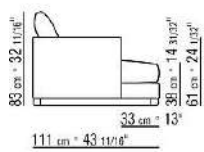

COD. 02D235

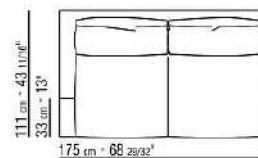
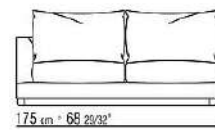
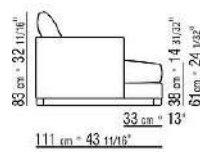

COD. 02D237

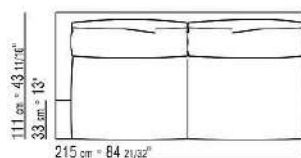
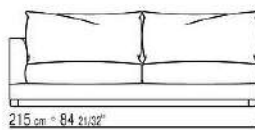
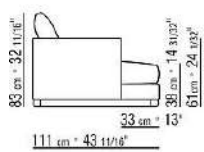

COD. 02D238

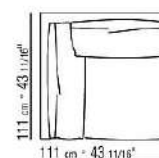
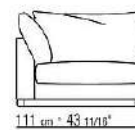

COD. 02D250

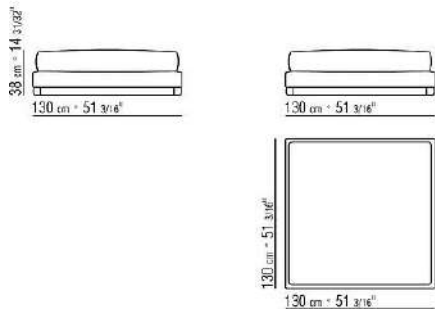

COD. 02D251

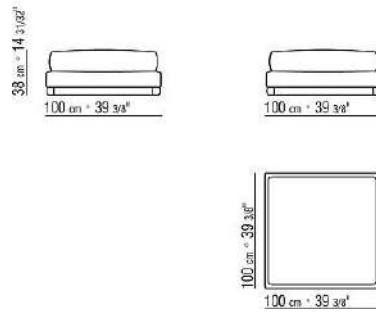

COD. 02D253

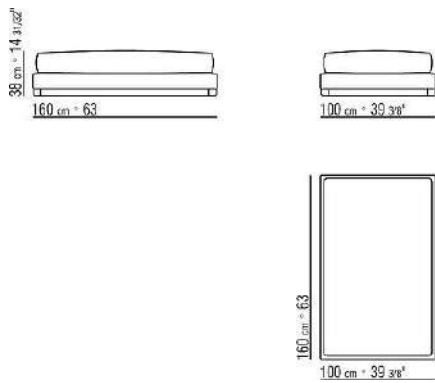

COD. 02D260

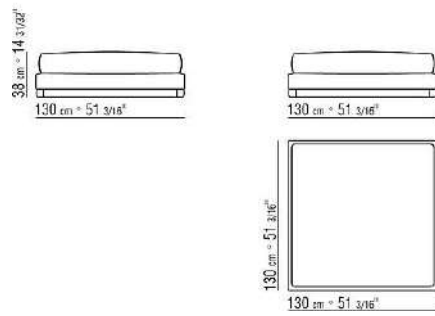

COD. 02D261

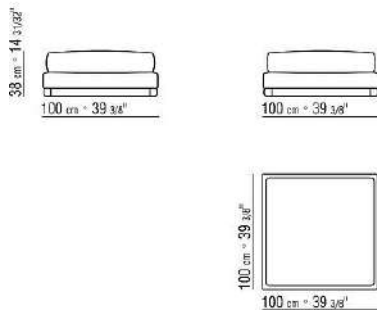

COD. 02D263

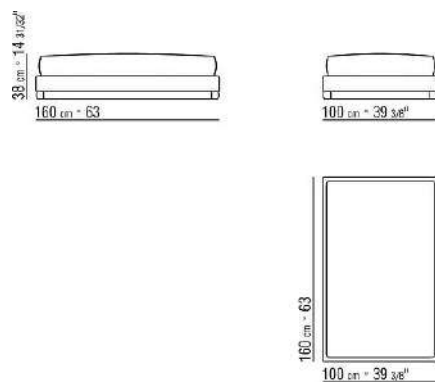

012VXA

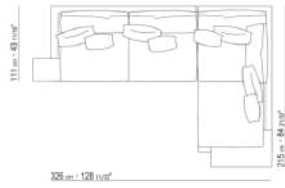

- N.1 COD.012V70 - SIDETABLE CM.33 x55
- N.1 COD.012V21 - LONG CORNER L CM.111 x215
- N.1 COD.012V27 - END UNIT L CM.215 x111
- N.1 COD.012V71 - SIDETABLE CM.90 x55
- N.4 COD.012V96 - CUSHION CM.40 x40
- N.4 COD.012V97 - CUSHION CM.60 x55

012VXB

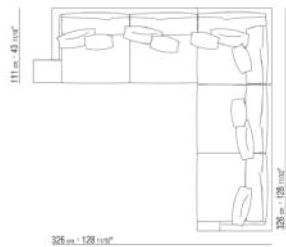

- N.1 COD.012V70 - SIDETABLE CM.33 x55
- N.1 COD.012V28 - CORNER CM.111 x111
- N.1 COD.012V27 - END UNIT L CM.215 x111
- N.1 COD.012V26 - END UNIT R CM.215 x111
- N.5 COD.012V96 - CUSHION CM.40 x40
- N.5 COD.012V97 - CUSHION CM.60 x55