



GRANDEMARE *ANTONIO CITTERIO* **2011**

SOFAS

GRANDEMARE | ANTONIO CITTERIO | 2011

Base in epoxy powder-coated metal. Rests on pads made of thermoplastic material

Seat frame in wood covered with hide leather: russian red 5008, olive 5006, black 5005, dark brown 5004, dark brown extra 5013, grey 5003, sand 5001, tobacco 5015. Also available in black suede 6005, dark brown suede 6004, olive suede 6003, sand suede 6001

Armrests and backrest in metal with polyurethane foam and sterilized goose down (Assopiuma certified, gold label) padding, covered with a protective laminated fabric

Seat cushions in sterilized goose down (Assopiuma certified, gold label) with insert in crushproof, variable density material

Backrest cushions in sterilized goose down (Assopiuma certified, gold label). Optional backrest cushions are upon request, with upcharge

Upholstery is removable in both the fabric and leather versions

Piping in gros grain, available in all the colors on the sample board, for both fabric and leather covers

COD. 015L01

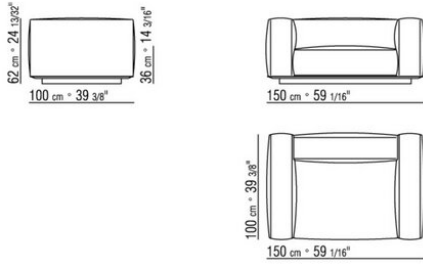

COD. 015L02

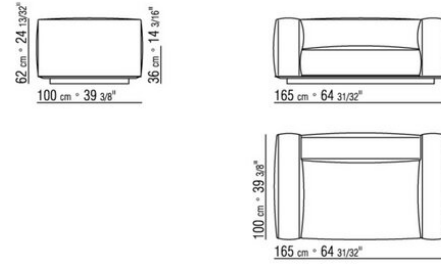

COD. 015L03

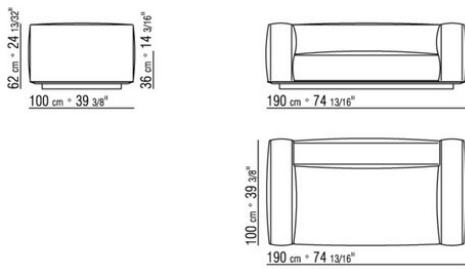

COD. 015L04

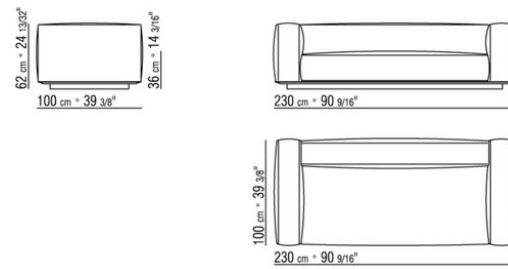

COD. 015L05

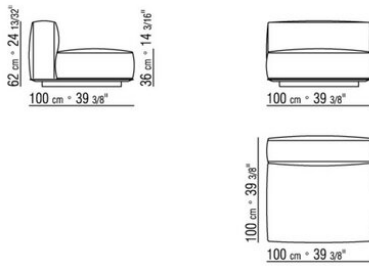

COD. 015L06

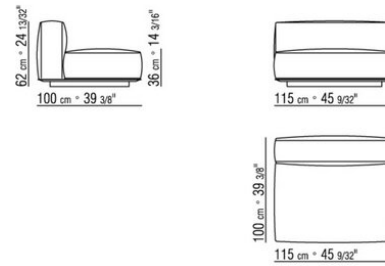

COD. 015L07

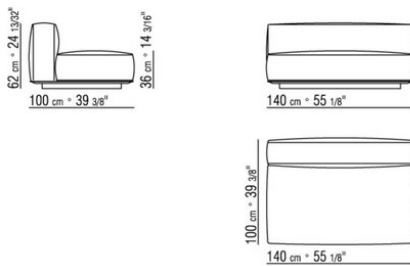

COD. 015L08

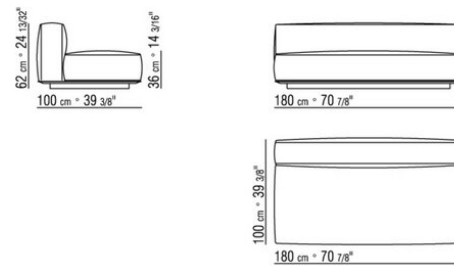

COD. 015L11

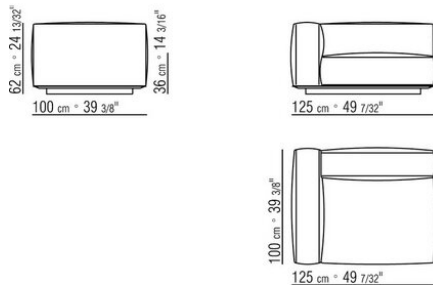

COD. 015L13

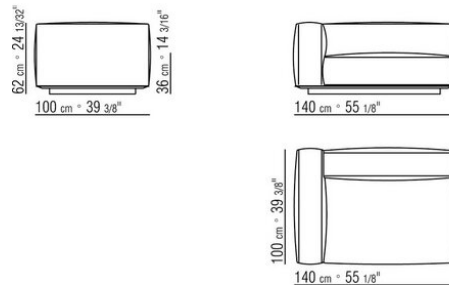

COD. 015L15

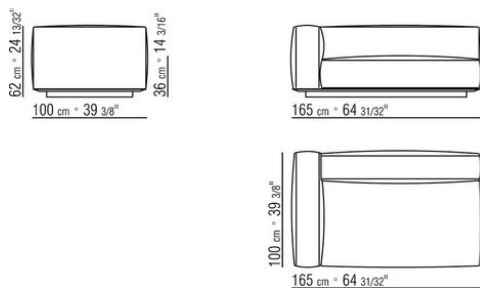

COD. 015L17

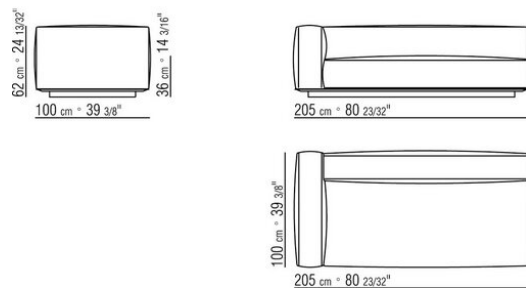

COD. 015L19

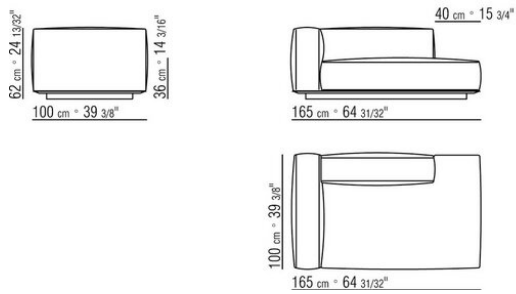

COD. 015L21

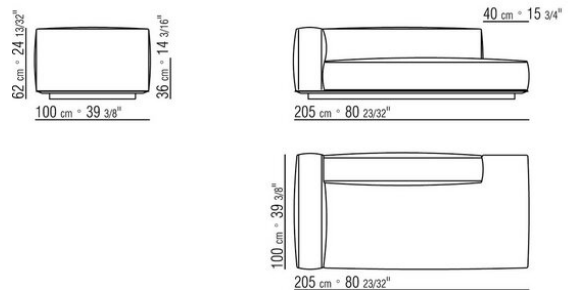

COD. 015L23

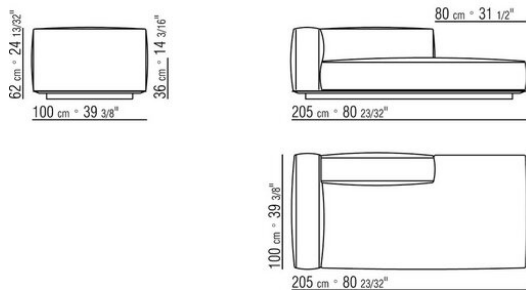

COD. 015L25

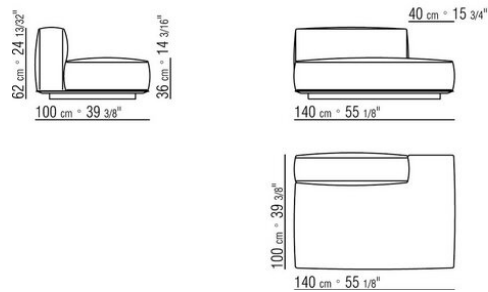

COD. 015L27

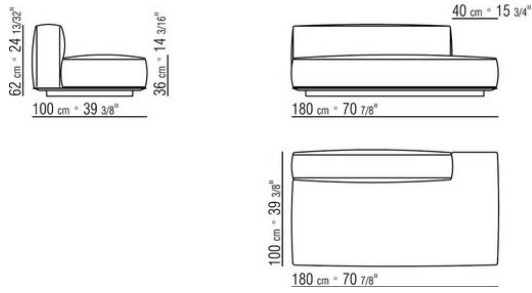

COD. 015L29

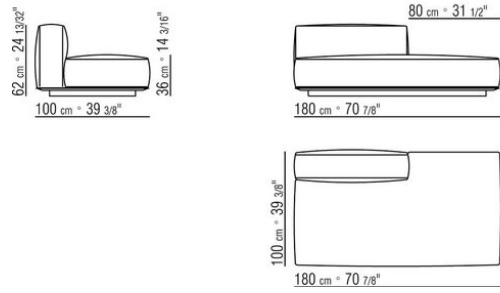

COD. 015L30

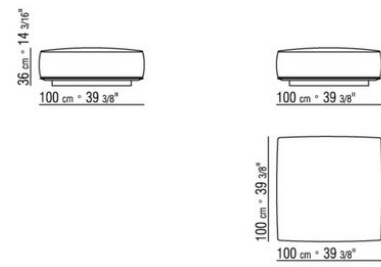

COD. 015L31

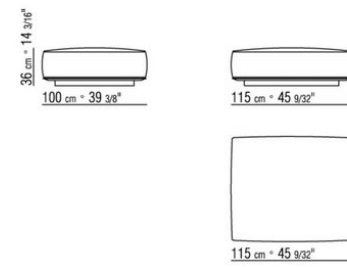

COD. 015L32

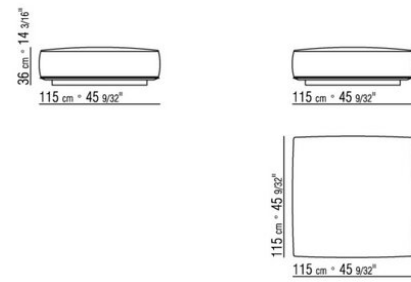

COD. 015L51

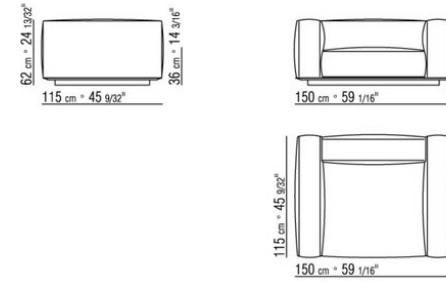

COD. 015L52

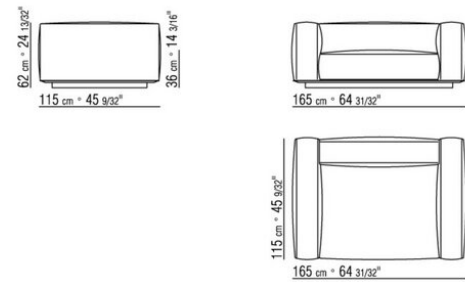

COD. 015L53

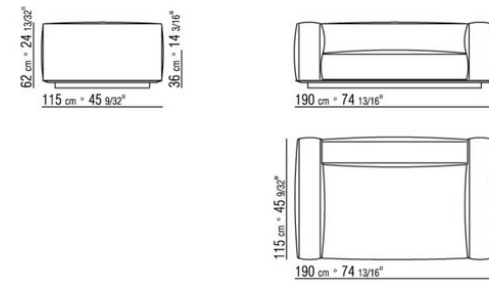

COD. 015L54

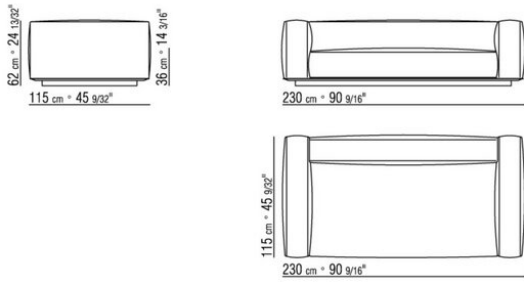

COD. 015L55

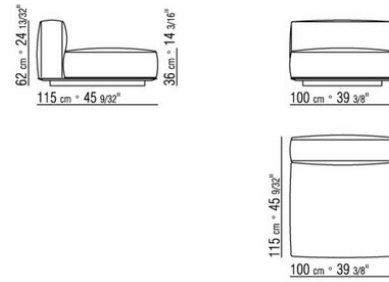

COD. 015L56

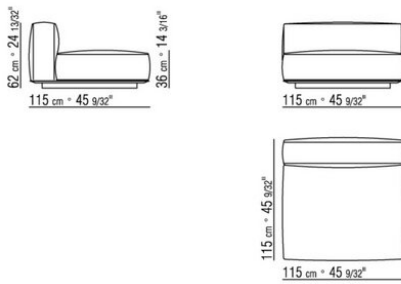

COD. 015L57

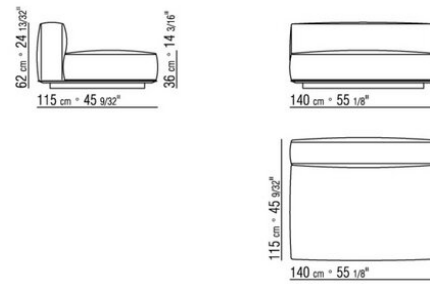

COD. 015L58

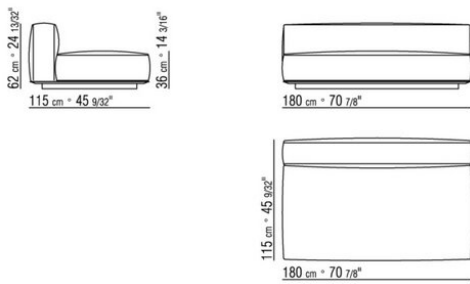

COD. 015L61

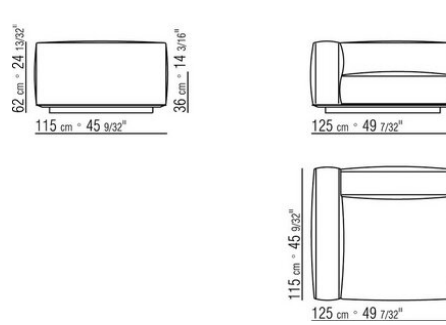

COD. 015L63

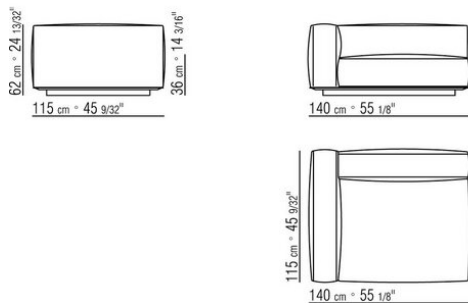

COD. 015L65

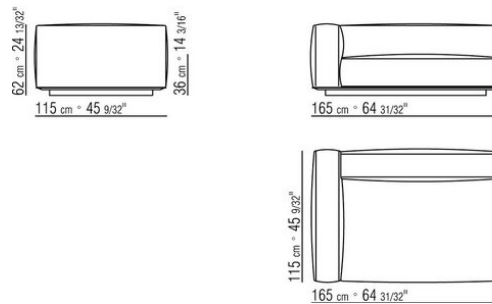

COD. 015L67

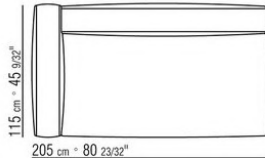
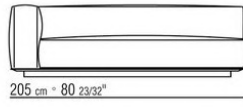
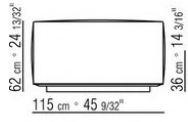

COD. 015L98

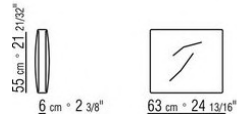

COD. 015L99

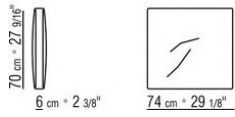

015LXA

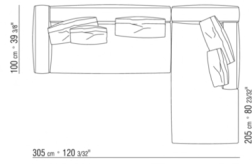

N.1 COD.015L17 - END UNIT L CM.205 x100

N.1 COD.015L23 - LONG CORNER L / SHORT ARM CM.205 x100

N.2 COD.015L98 - CUSHION CM.63 x55

N.3 COD.015L99 - CUSHION CM.74 x70

015LXB

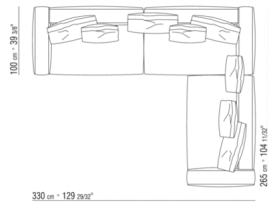

N.1 COD.015L15 - END UNIT L CM.165 x100

N.2 COD.015L14 - END UNIT R CM.165 x100

N.4 COD.015L98 - CUSHION CM.63 x55

N.4 COD.015L99 - CUSHION CM.74 x70