



## simply design gianmaria e stefano conficconi 2017

Modular sofa with wooden and metal seat frame supported by elastic belts. The seat cushion is made of a double layer quilted cover with a core of polyurethane foam and is placed on a base of polyurethane foam. The adjustable back cushions and armrests have a metal frame padded with polyurethane foam. The loose lumbar cushions are filled with sterilized hypoallergenic goose-down. The legs are in dark brown painted or chromed metal.

Divano modulare con struttura sedile in legno e metallo, con supporto di nastri elastici. Il materassino di seduta è formato da un doppio strato di falda trapuntata con anima in poliuretano e poggia su uno strato di poliuretano espanso. Gli schienali e i braccioli reclinabili sono in metallo rivestiti in poliuretano espanso. I poggiatesta asportabili sono in piuma d'oca sterilizzata analergica. I piedi sono in metallo verniciato color moka o cromato lucido.

### seat height

altezza seduta  
43 cm  
16.9"

### seat depth

profondità seduta  
55 cm  
21.6"

### arm width

larghezza braccio  
18 cm  
7.1"

### arm height

altezza braccio  
47 cm  
30.3"

### feet height

altezza piede  
14 cm  
5.5"

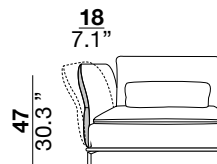
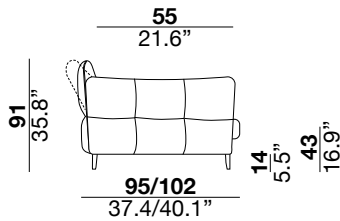

1

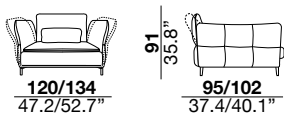

2



3



SX



01

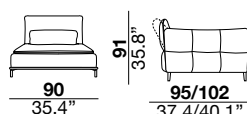

05/06

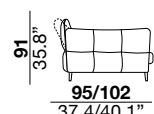
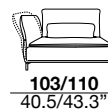

07/08

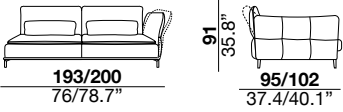
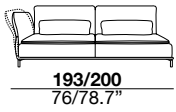

29/30

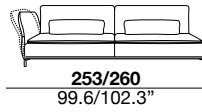

S09/S10

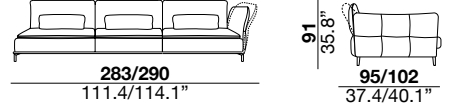
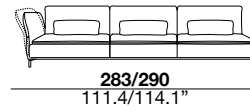

17/18

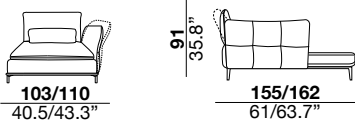
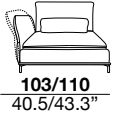

19/20

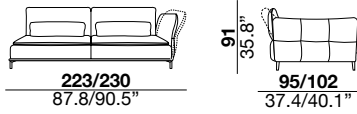
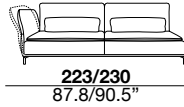

37/38

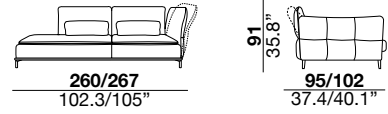
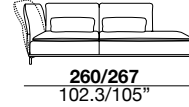

T11/T12

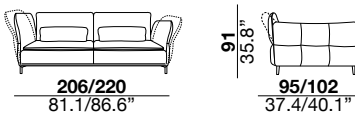
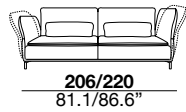

T13/T14

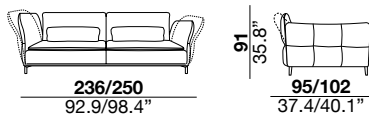
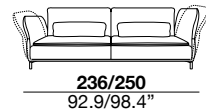

T21/T22

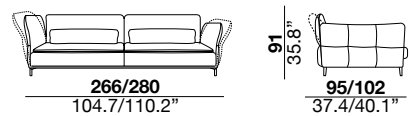
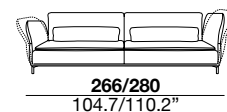

T23/T24

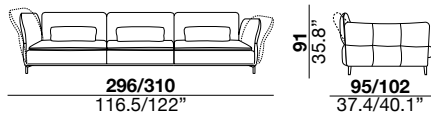
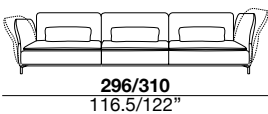

PRT

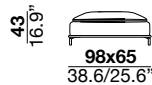

T23+08

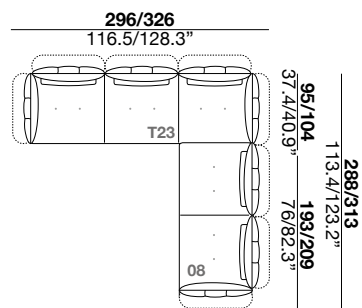

T11+08

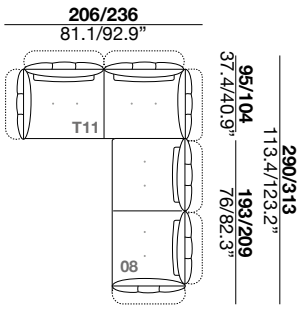

T13+20

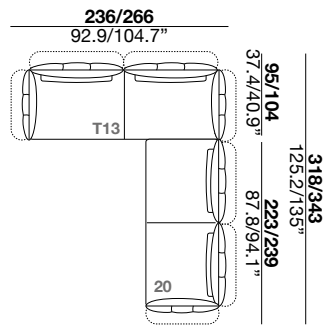

T21+30

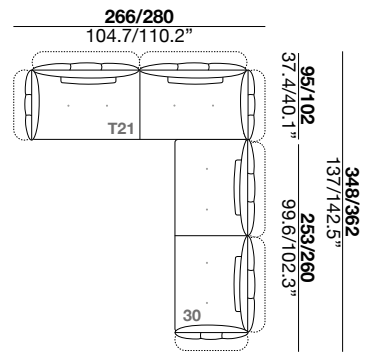

T23+S10

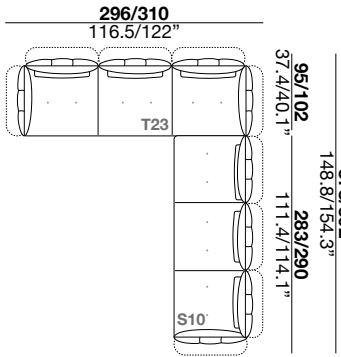

07+37

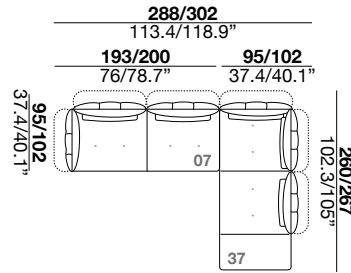

19+18

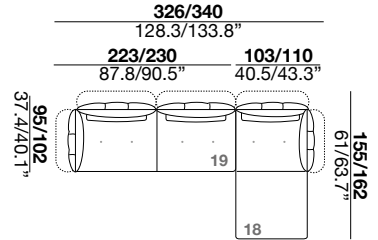

S09+37

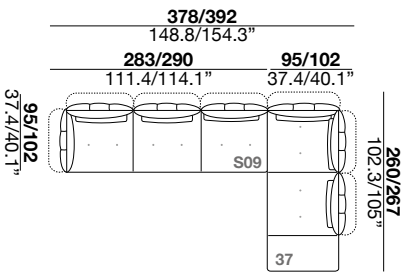

07+18

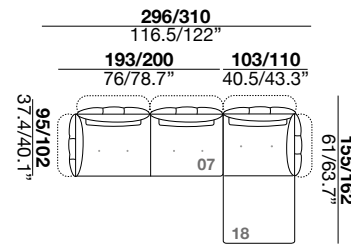



## simply II design gianmaria e stefano conficconi 2017

Modular sofa with wooden and metal seat frame supported by elastic belts. The seat cushion is made of a double layer quilted cover with a core of polyurethane foam and is placed on a base of polyurethane foam. The adjustable back cushions and armrests have a metal frame padded with polyurethane foam. The loose lumbar cushions are filled with sterilized hypoallergenic goose-down. The legs are in dark brown painted or chromed metal.

Divano modulare con struttura sedile in legno e metallo, con supporto di nastri elastici. Il materassino di seduta è formato da un doppio strato di falda trapuntata con anima in poliuretano e poggia su uno strato di poliuretano espanso. Gli schienali e i braccioli reclinabili sono in metallo rivestiti in poliuretano espanso. I poggiatesta asportabili sono in piuma d'oca sterilizzata analergica. I piedi sono in metallo verniciato color moka o cromato lucido.

### seat height

altezza seduta  
43 cm  
16.9"

### seat depth

profondità seduta  
46 cm  
18.1"

### arm width

larghezza braccio  
18 cm  
7.1"

### arm height

altezza braccio  
47 cm  
30.3"

### feet height

altezza piede  
14 cm  
5.5"

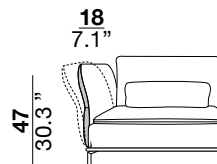
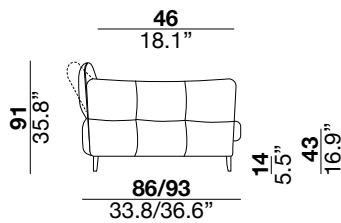

1

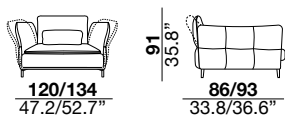

2



3



SX

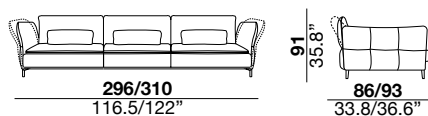

01

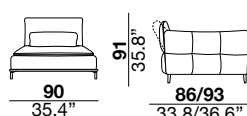

05/06

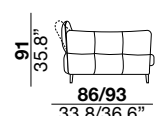

07/08

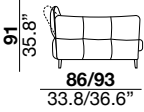
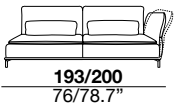
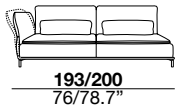

29/30

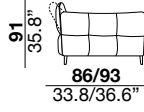
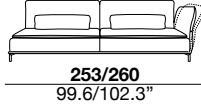
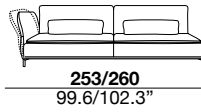

S09/S10

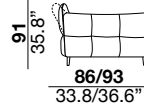
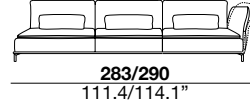
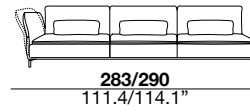

17/18

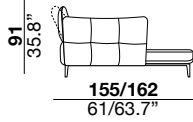
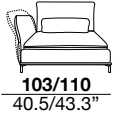

19/20

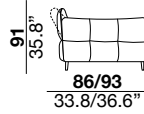
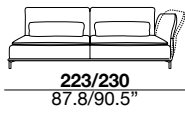
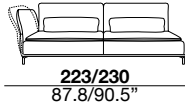

37/38

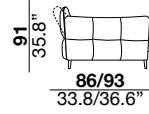
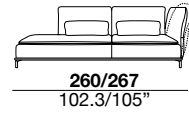
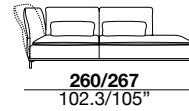

T11/T12

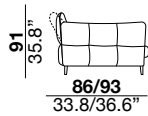
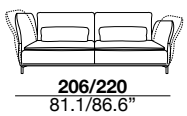
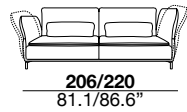

T13/T14

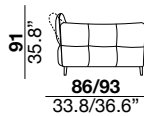
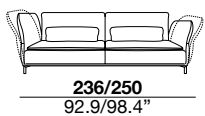
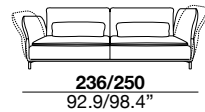

T21/T22

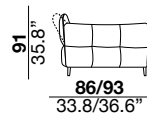
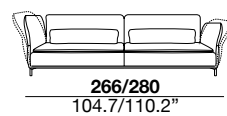
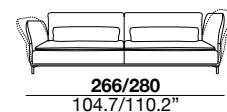

T23/T24

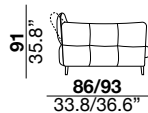
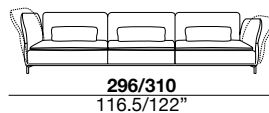
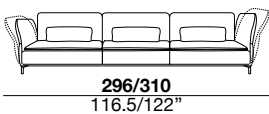

PRT

