



Olli design studio tenico cierre 2015

Modular sofa with a wooden frame supported by elastic belts. The wooden armrests are upholstered with expanded polyurethane foam. The seat cushion is filled with expanded polyurethane foam covered by sterilized hypoallergenic goose-down. The back cushions are filled with sterilized hypoallergenic goose-down. The base is in black chromed metal available also polished chrome. The feet are in black plastic.

Divano modulare con fusto in legno e supporto di nastri elastici. I braccioli sono in legno ricoperti in poliuretano espanso. Il cuscino di seduta è realizzato in poliuretano espanso ricoperto in piuma d'oca sterilizzata analergica. I cuscini schienali sono imbottiti in piuma d'oca sterilizzata analergica. Il basamento è in metallo cromato nero disponibile anche lucido. Piedini in plastica nera.

seat height

altezza seduta
42 cm
16.5"

seat depth

profondità seduta
71 cm
27.9"

arm width

larghezza braccio
25 cm
9.8"

arm height

altezza braccio
63 cm
24.8"

feet height

altezza piede
2,5 cm
1"

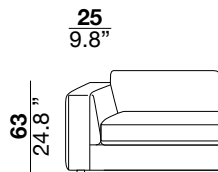
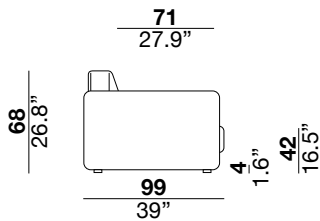

3



X

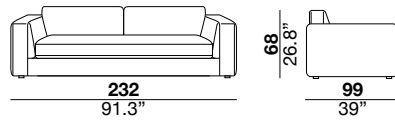

01

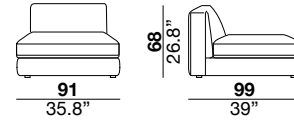

40

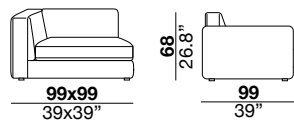

33

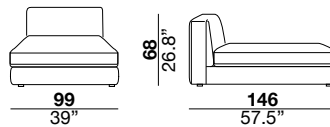

19/20

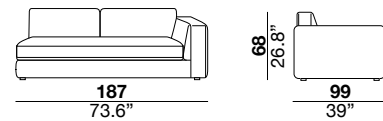
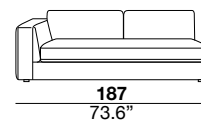

29/30

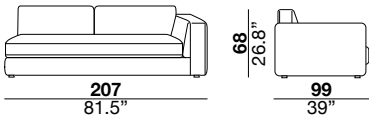
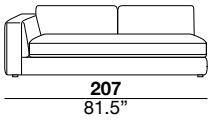

17/18

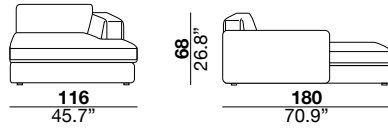
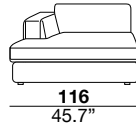

37/38

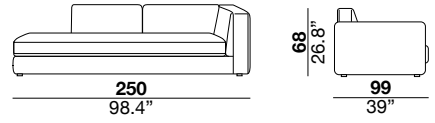
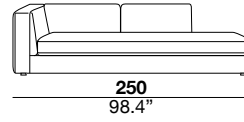

75/76

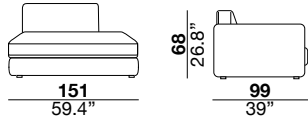
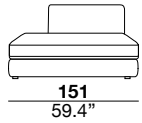

77/78

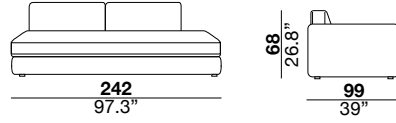
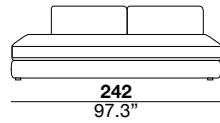

PQU

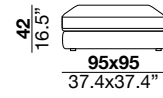

C75



COR

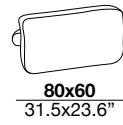

C50



PR

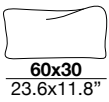

19+18+(x3)C75

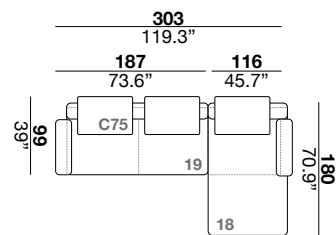

29+18+(x3)C75

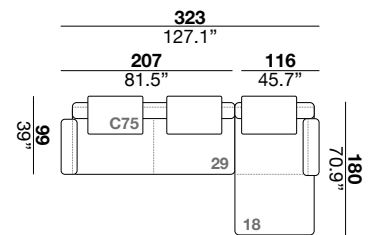

29+37+(x4)C75

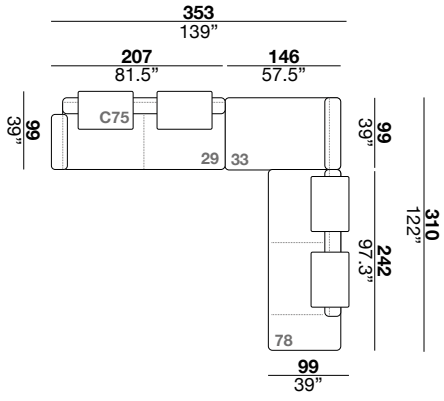

29+33+78+(x4)C75

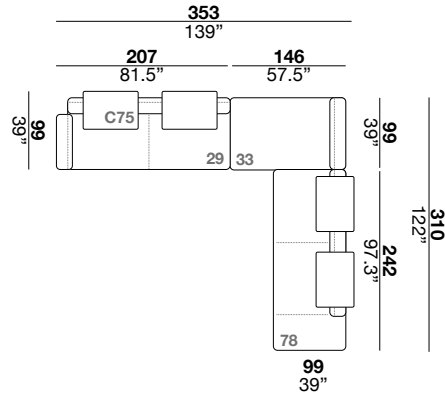

19+33+76+(3x) C75

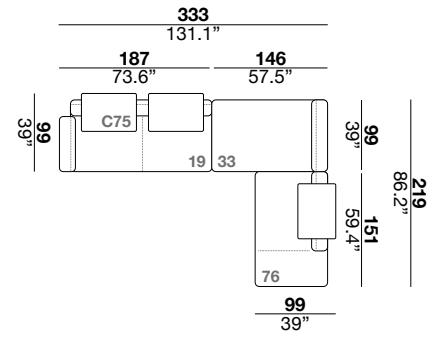

29+PQU+37+(x4)C75

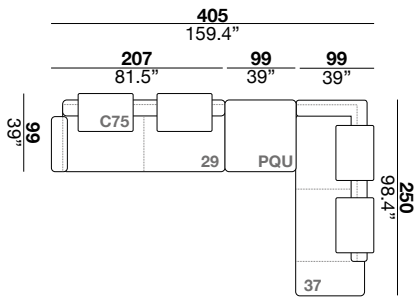

29+40+78+(x4)C75

