



## clift design marco fumagalli 2019

Modular sofa with metal structure and wooden frame. Elastic belts support. Seat cushions in polyurethane foam with three different densities and memory foam covered with acrylic fiber. The backrests and armrests are in metal, covered with expanded polyurethane foam and acrylic fiber. Black plastic legs.

Divano modulare con struttura in metallo e telaio in legno. Supporto di nastri elastici. Cuscini di seduta in poliuretano espanso con tre densità differenti e memory foam rivestito con falda acrilica. Schienali e braccioli in metallo rivestiti con poliuretano espanso e falda acrilica. Piedi in polimero nero.

### seat height

altezza seduta  
45 cm  
17.7"

### seat depth

profondità seduta  
56 cm  
22"

### arm width

larghezza braccio  
28 cm  
11"

### arm height

altezza braccio  
64 cm  
25.2"

### feet height

altezza piede  
4 cm  
1.5"

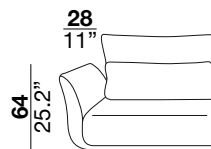
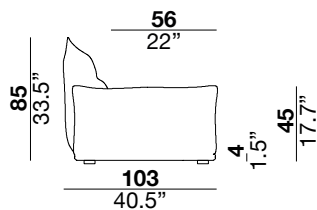

2

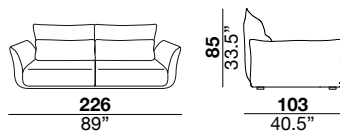

3

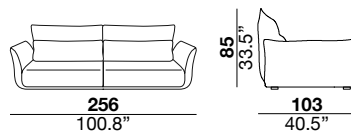

SX

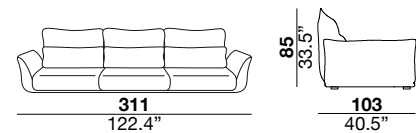

05/06

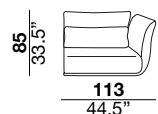
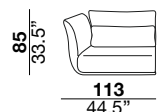

07/08

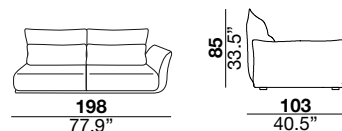
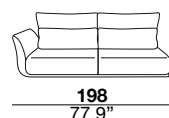

19/20

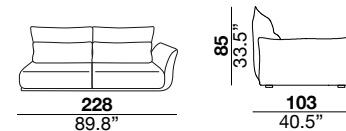
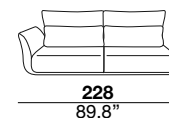

09/10

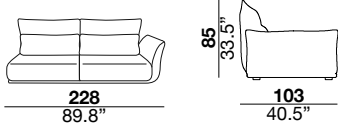
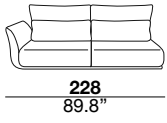

15/16

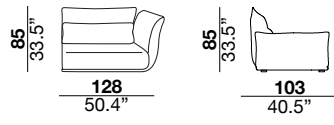
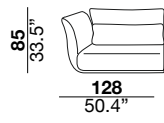

17/18

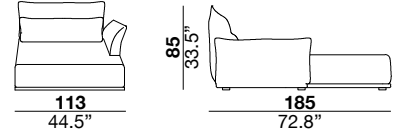
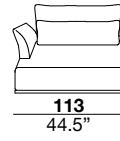

01

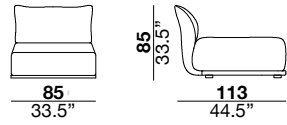

01B

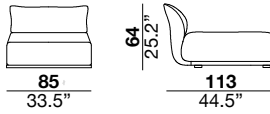

02

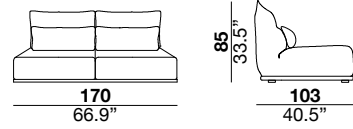

40

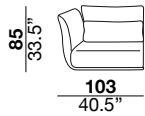
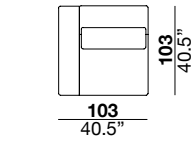

75B/76B

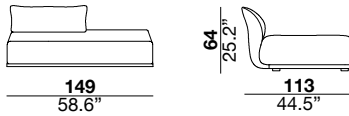
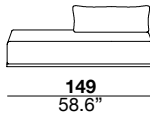

CSR

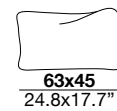

07+18

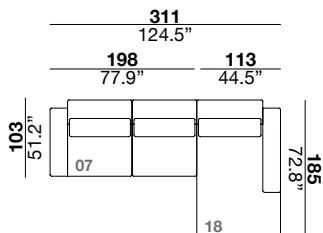

19+18

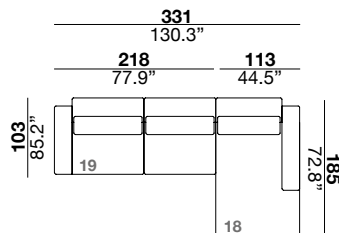

09+18

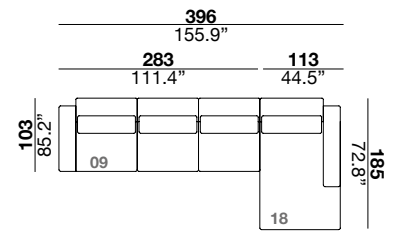

07+40+08

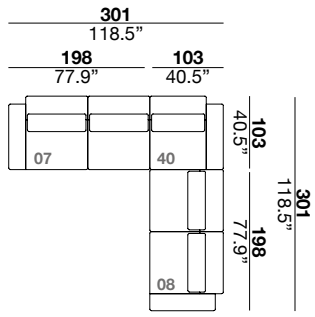

SX+01B+76B

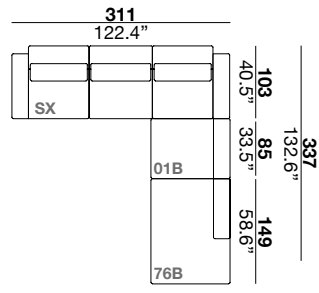

07+08+01B+76B

