

# MET

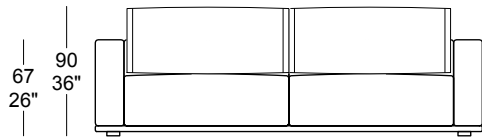

**MET 01**

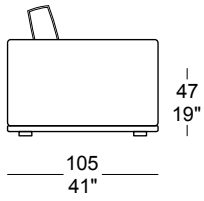
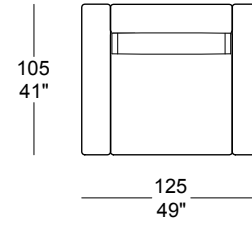

**MET 02**

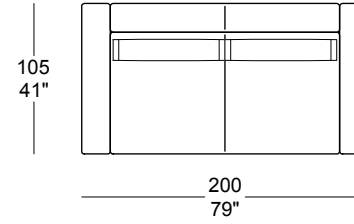

**MET 03**

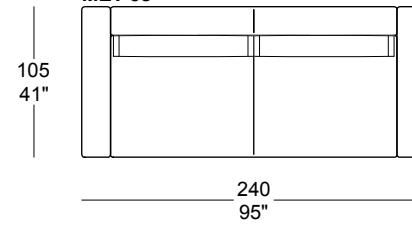

**MET 04**

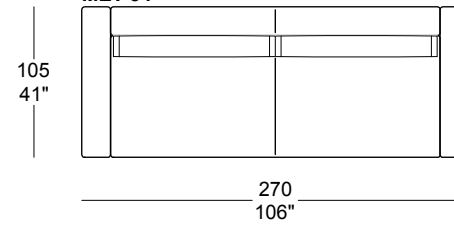

# MET

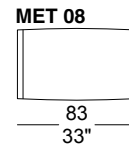
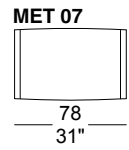
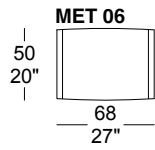
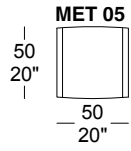

2 ▶

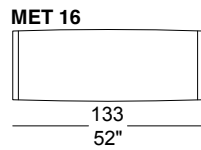
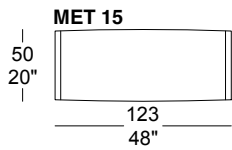
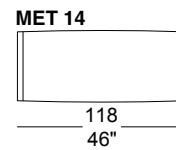
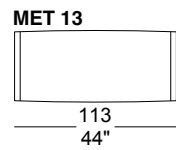
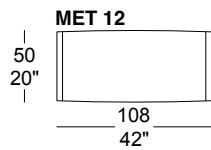
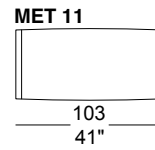
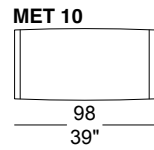
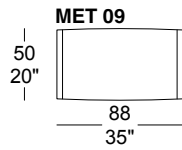

# MET

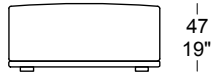

47  
19"

**MET 22**

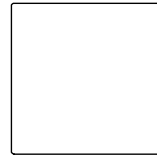

105  
41"

105  
41"

**MET 23**

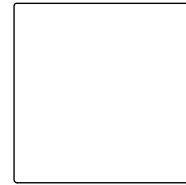

125  
49"

125  
49"

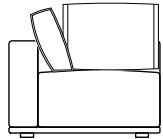

47  
19"

67  
26"

90  
35"

105  
41"

**MET 24**

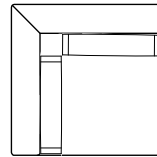

105  
41"

105  
41"

# MET

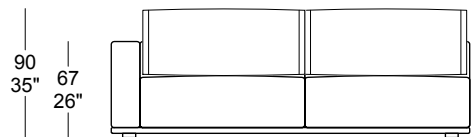
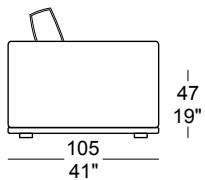

**MET 25**

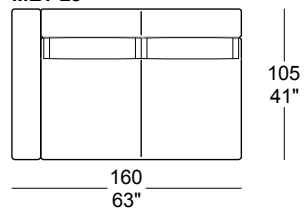

**MET 29**

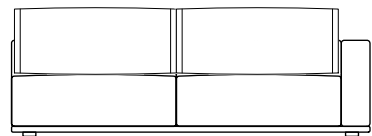
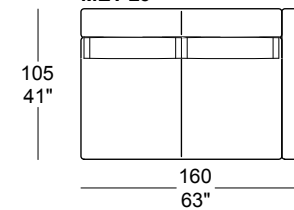

**MET 26**

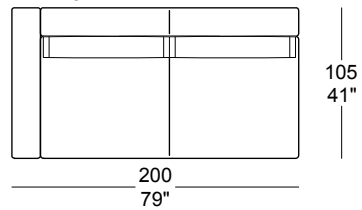

**MET 30**

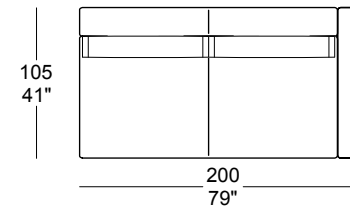

4 ▶

**MET 27**

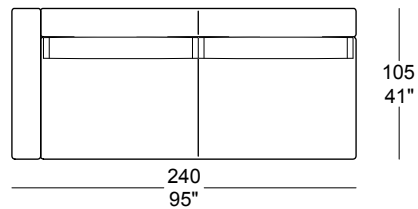

**MET 31**

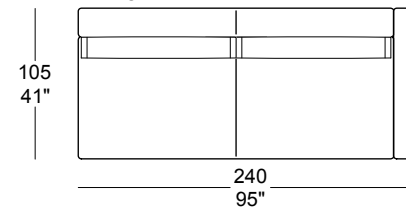

**MET 28**

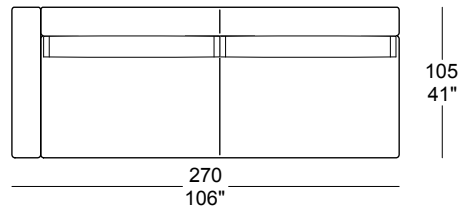

**MET 32**

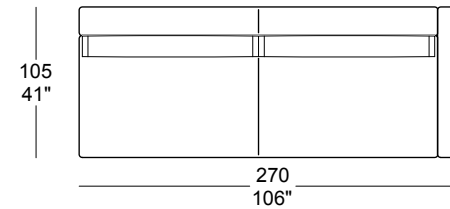

# MET

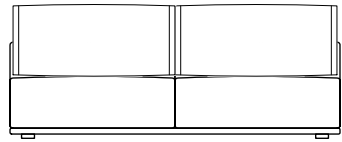
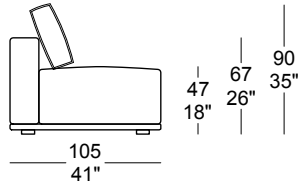

5 ▶

**MET 33**

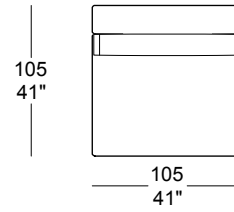

**MET 34**

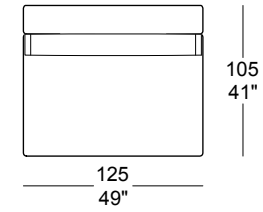

**MET 35**

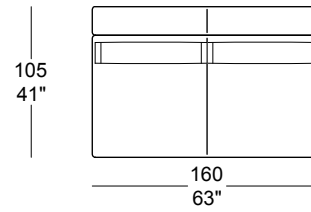

**MET 36**

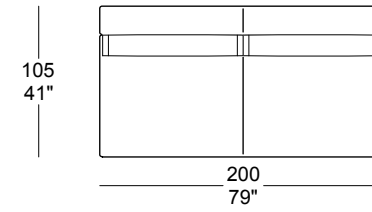

**MET 37**

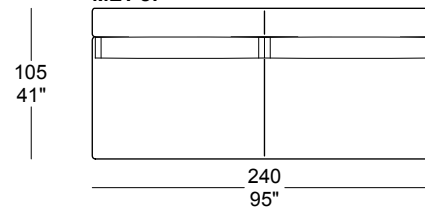

**MET 38**

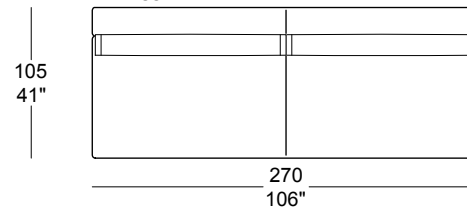

**MET**

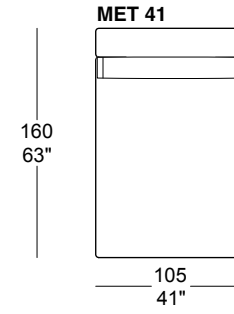
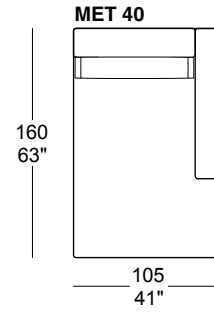
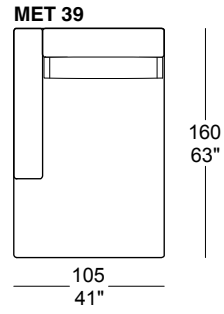
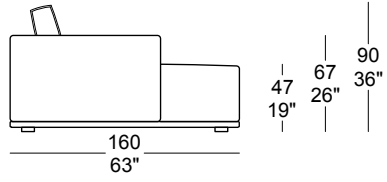

6 ▶

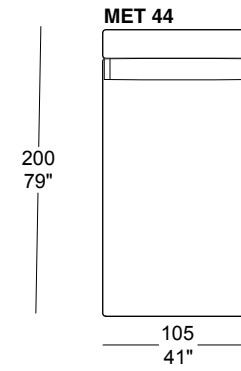
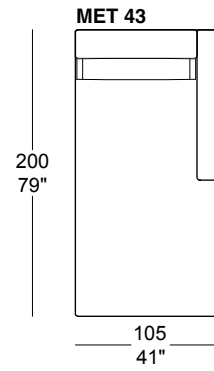
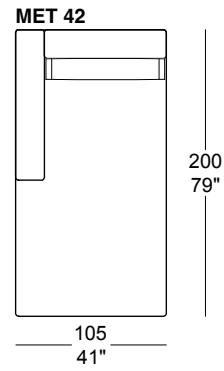
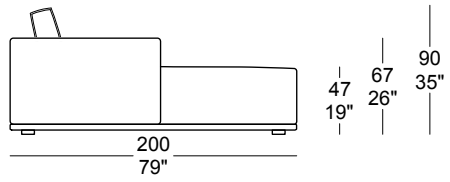

**MET**

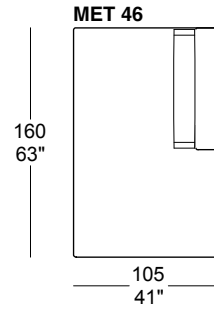
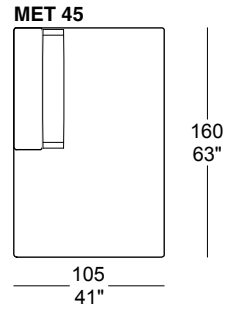
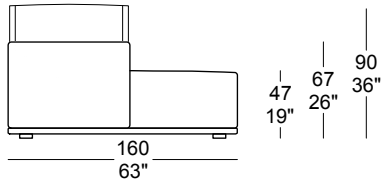

7 ▶

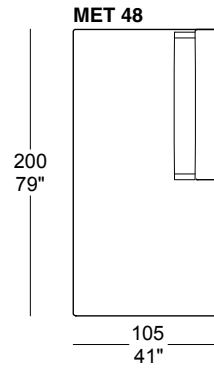
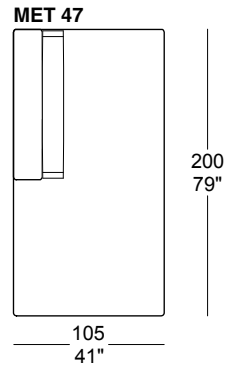
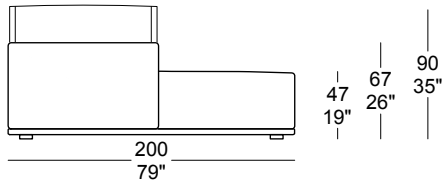

MET

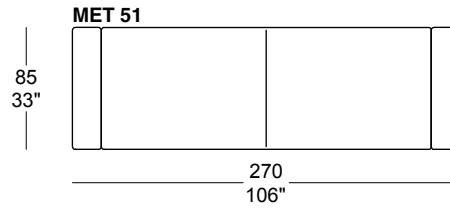
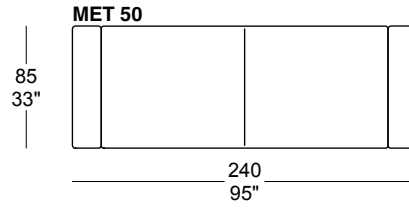
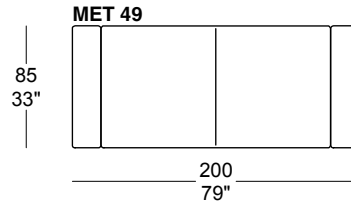
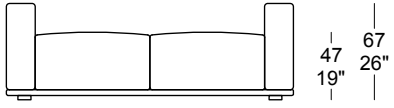

**MET**

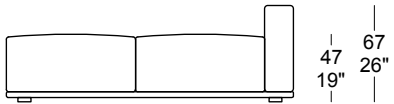
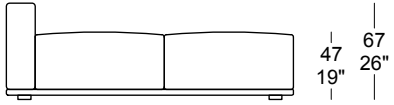

**MET 52**

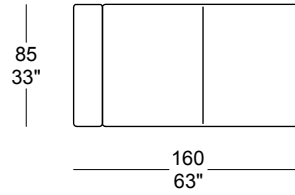

**MET 56**

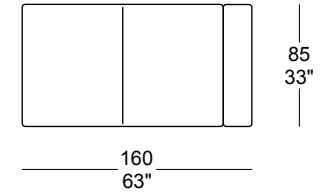

**MET 53**

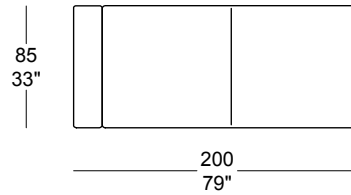

**MET 57**

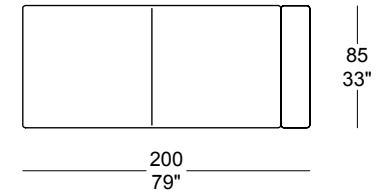

9 ▶

**MET 54**

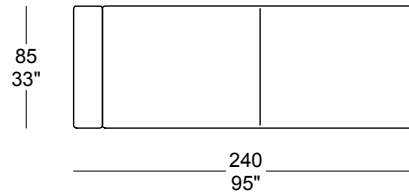

**MET 58**

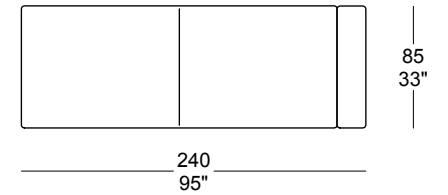

**MET 55**

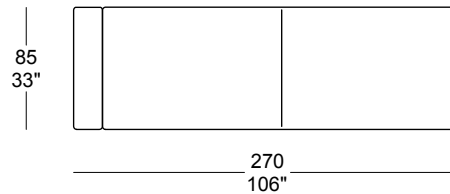

**MET 59**

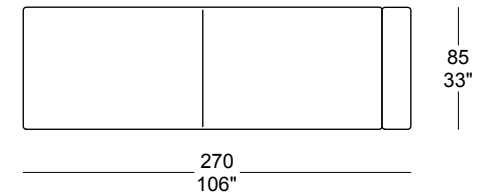

# MET

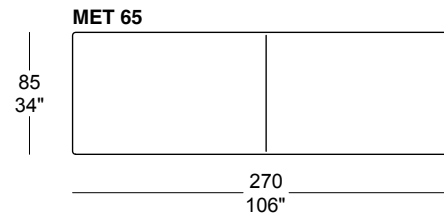
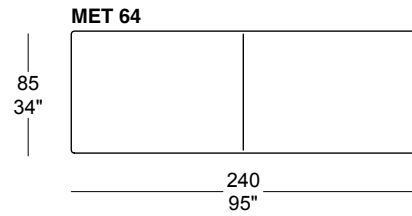
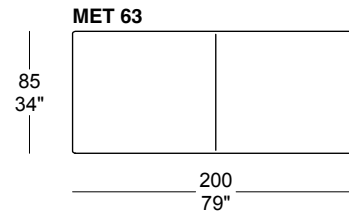
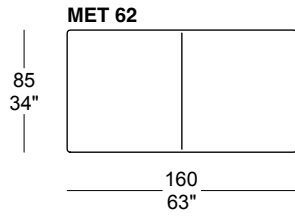
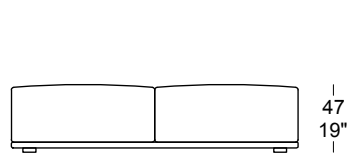
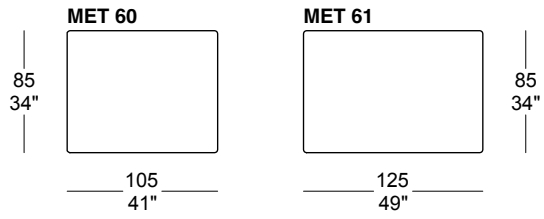

# MET

**MET 66**

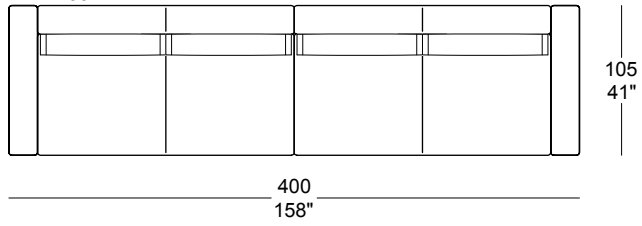

**MET 67**

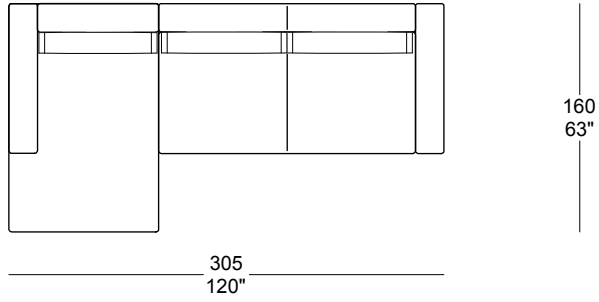

**MET 68**

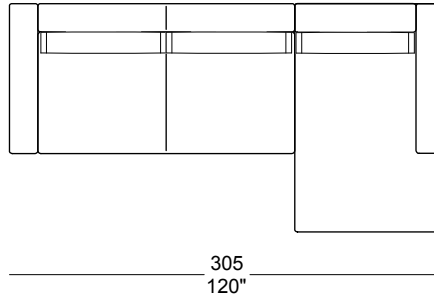

**MET 69**

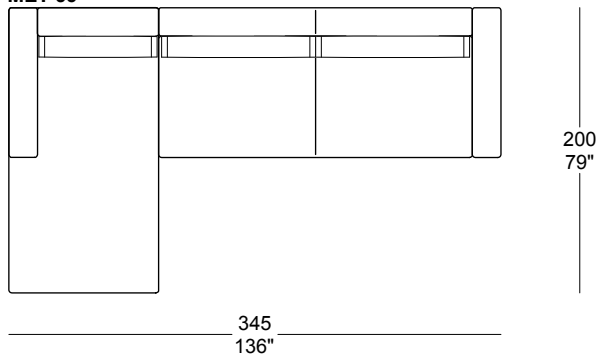

**MET 70**

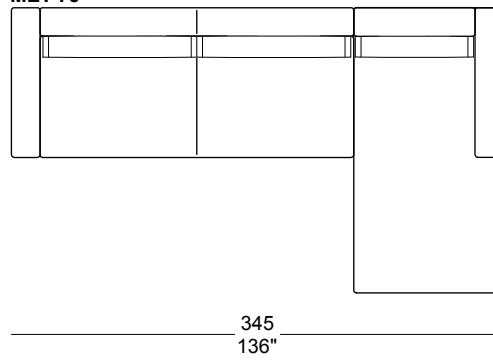

**MET**

**MET 71**

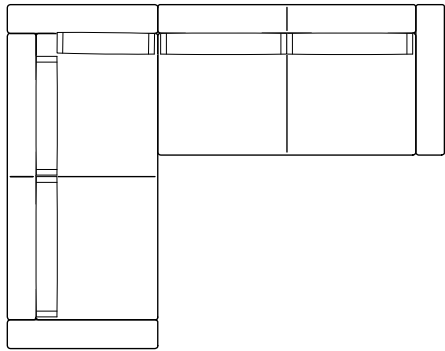

240  
95"

305  
120"

**MET 72**

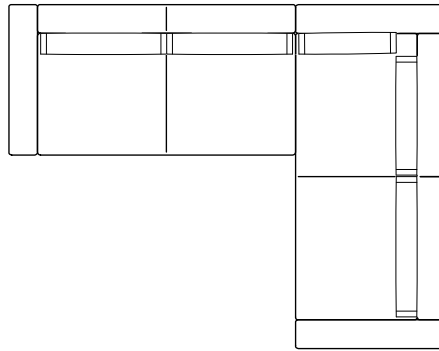

305  
120"

12 ▶

**MET 73**

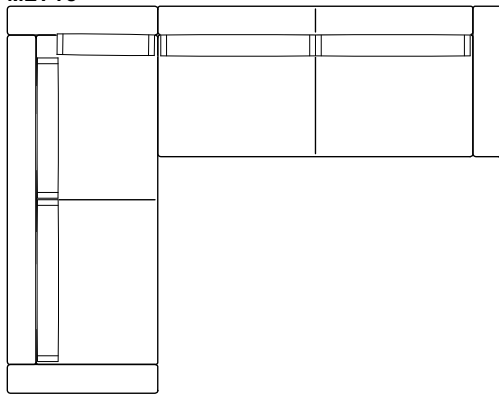

270  
106"

345  
136"

**MET 74**

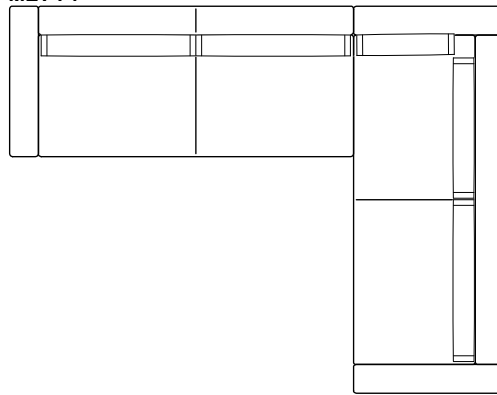

345  
136"

MET

MET 75

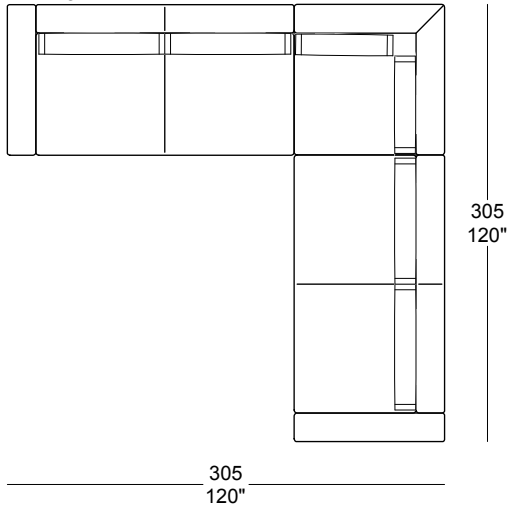

MET 76

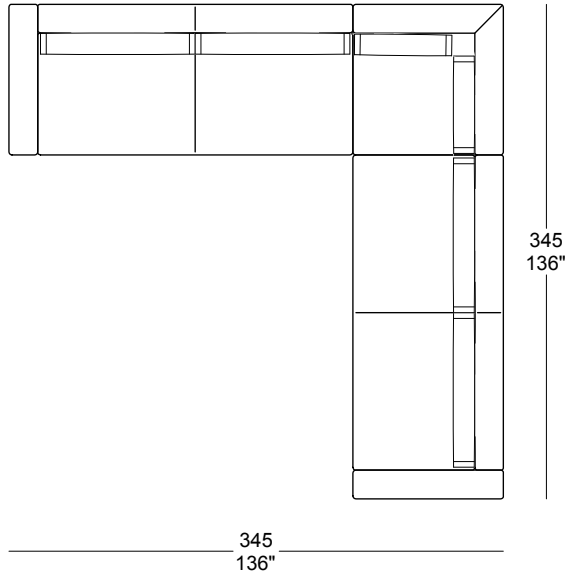

MET 77

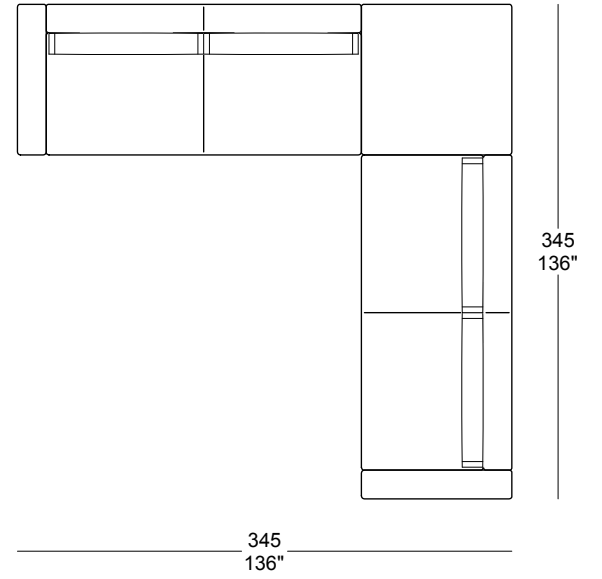

13 ▶

MET 78

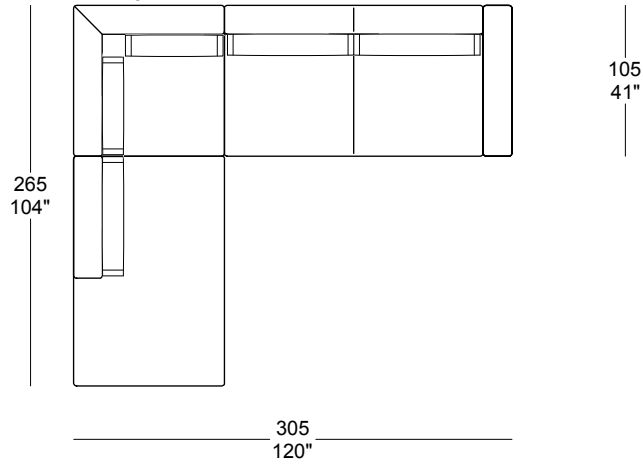

MET 79

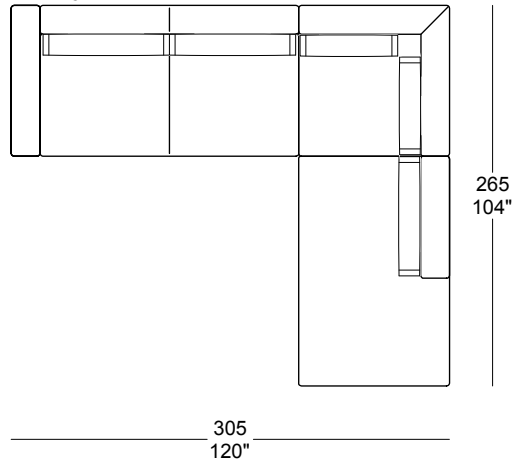

MET

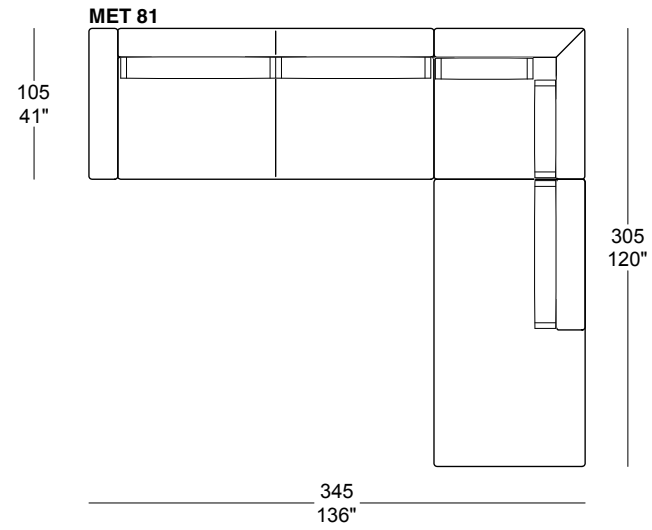
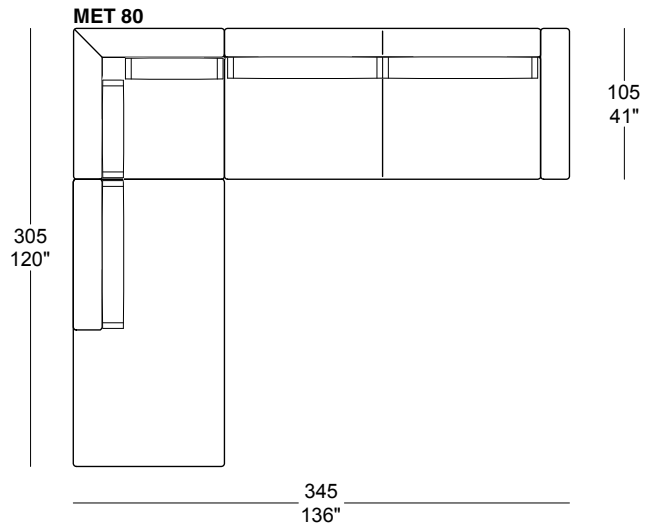

14 ►

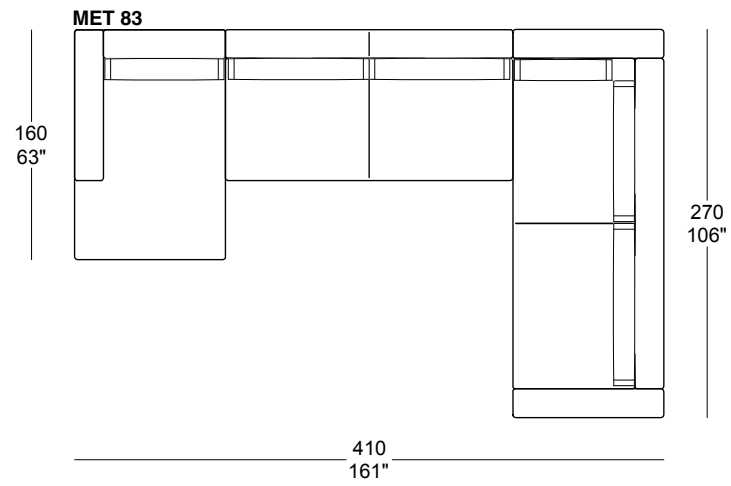
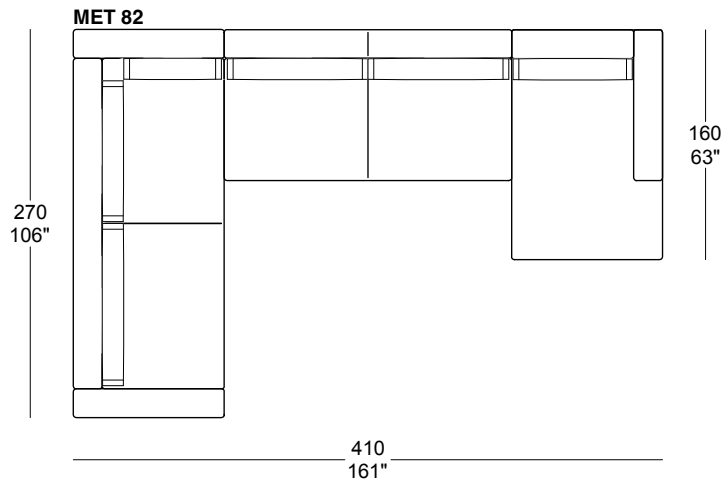

# MET

**MET 84**

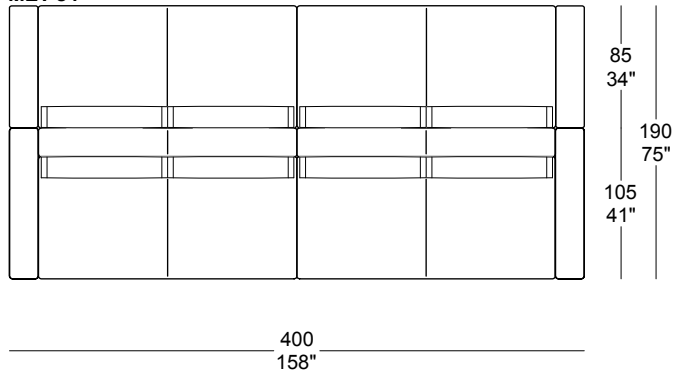

15 ▶

**MET 85**

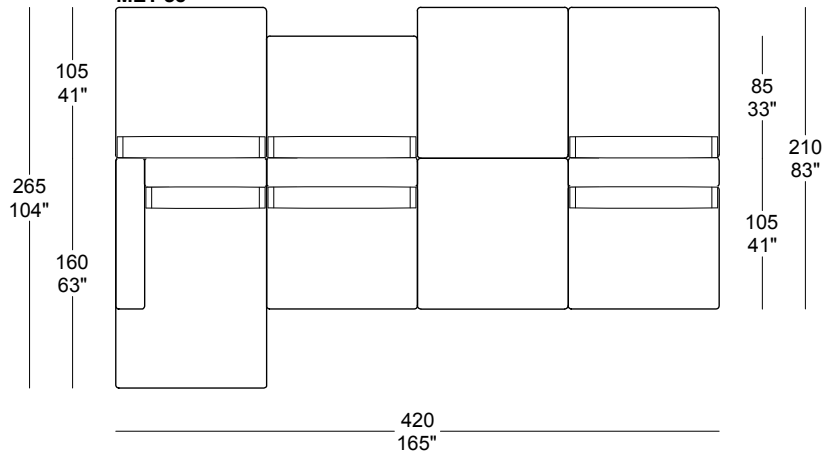

**MET 86**

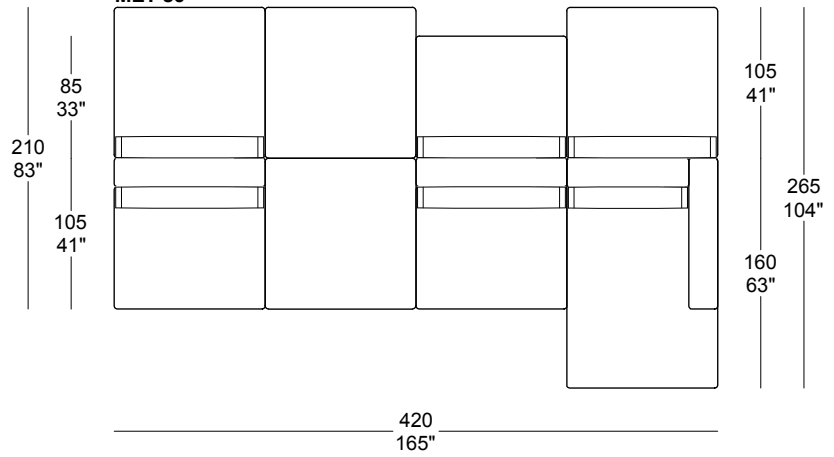

MET

MET 87

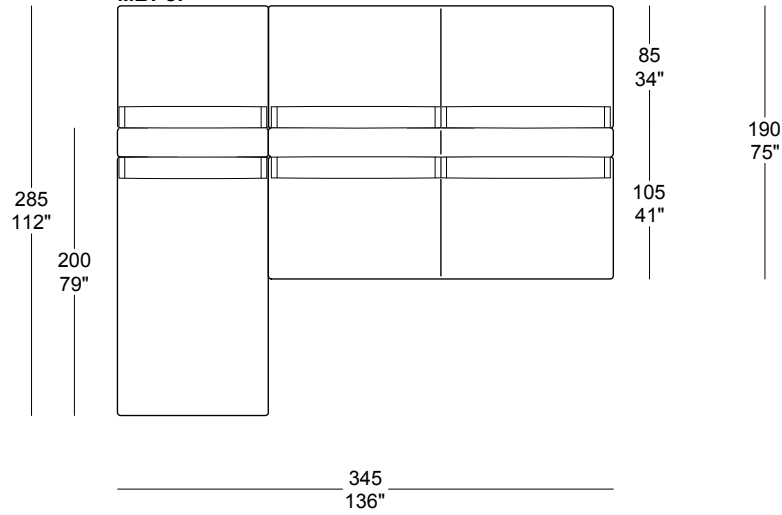

MET 88

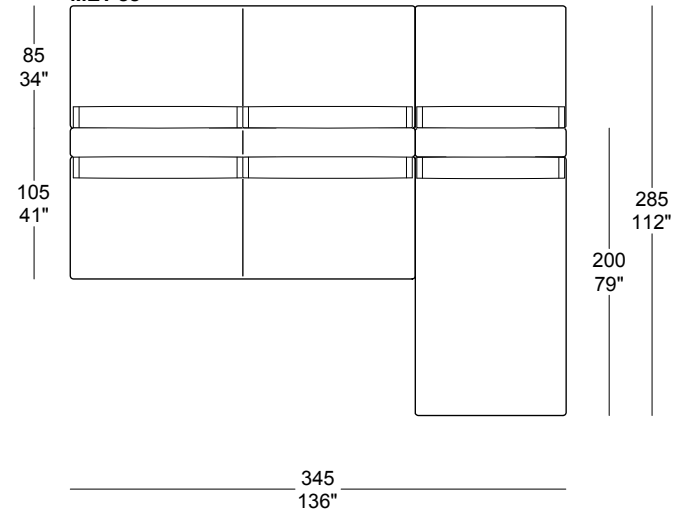

16 ▶

MET 89

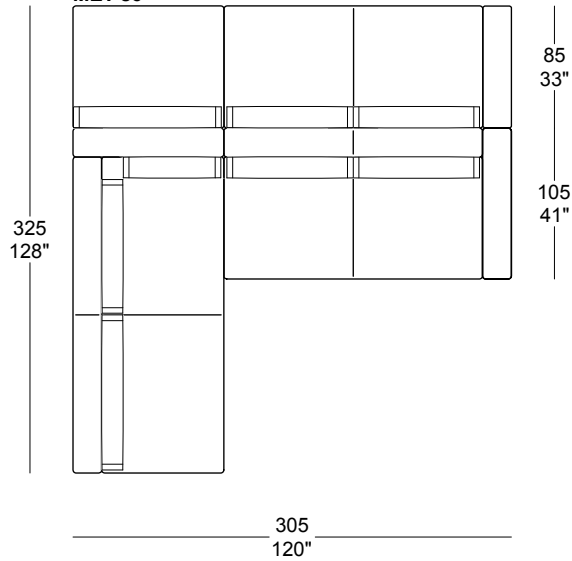

MET 90

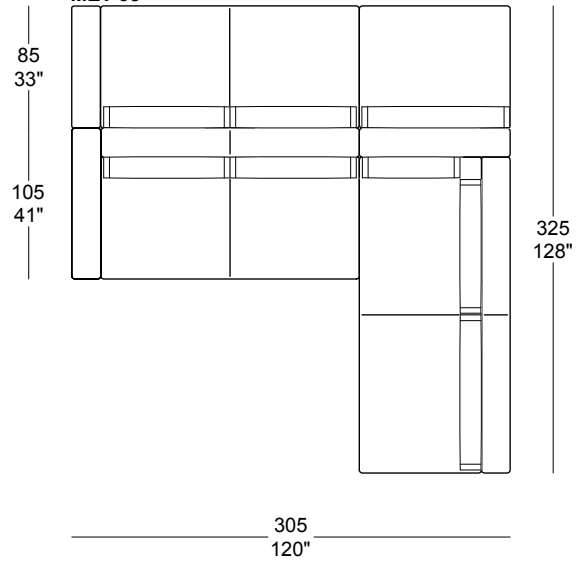

# MET

17 ▶

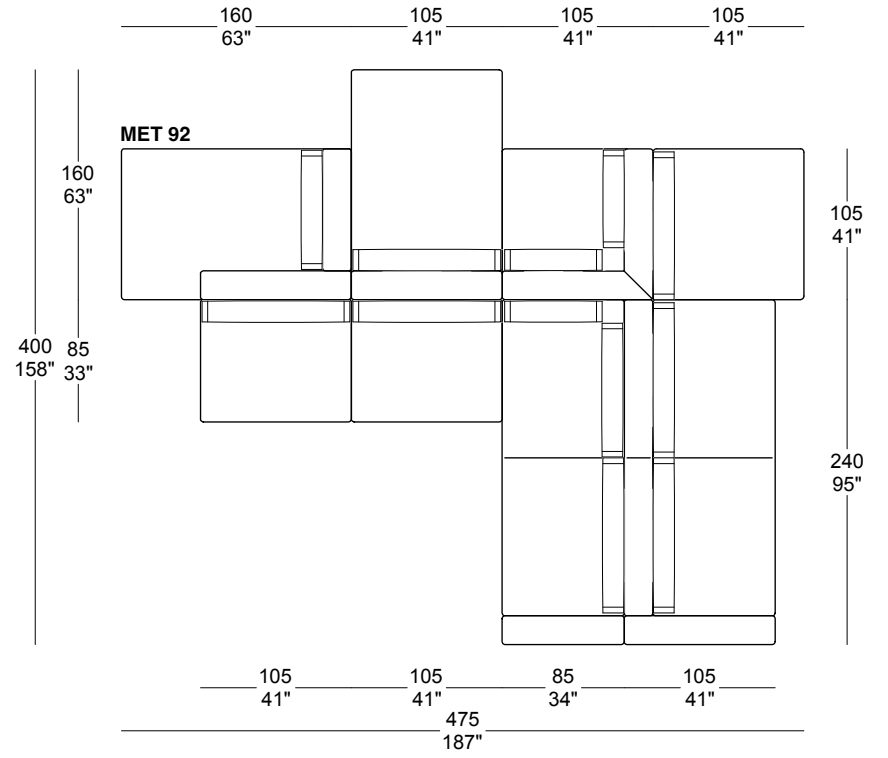
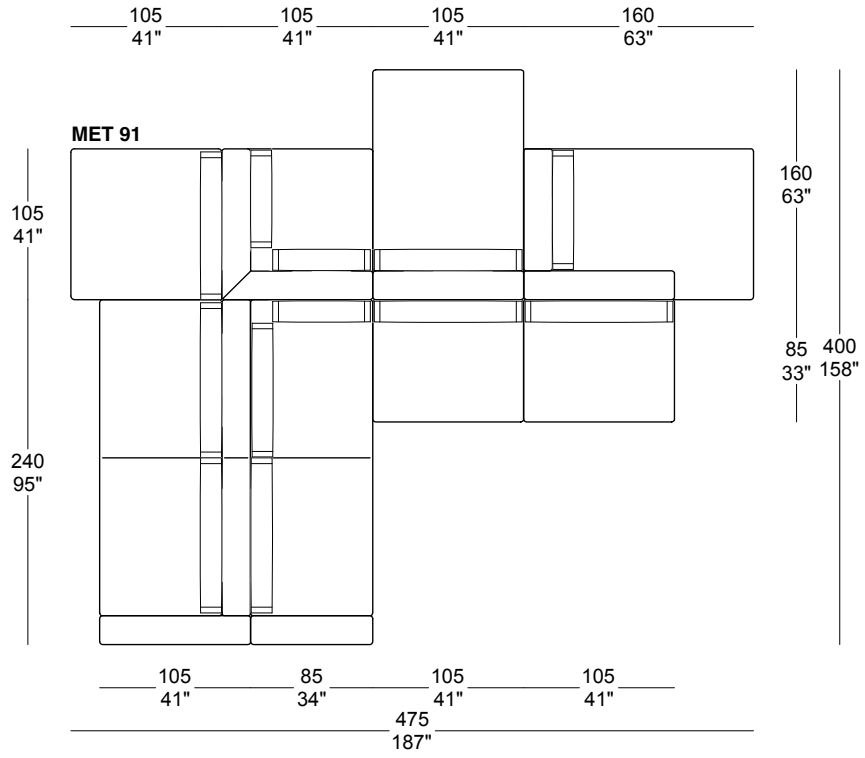

MET

MET 93

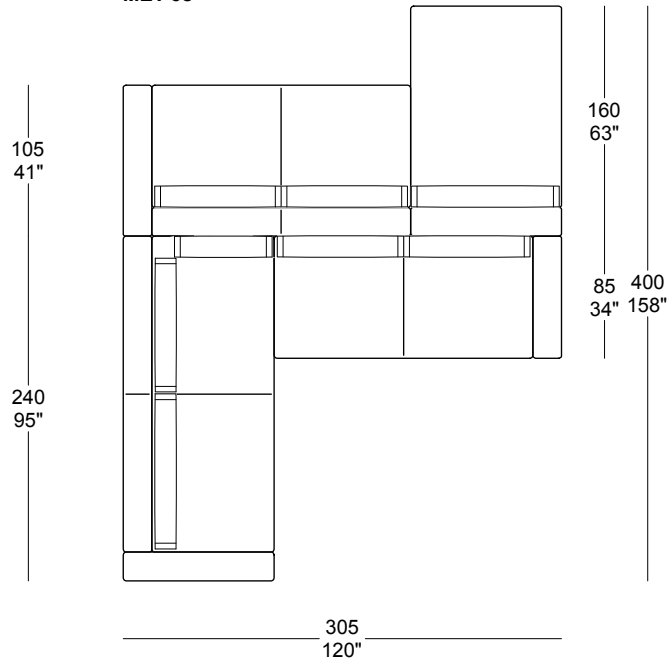

MET 94

