

# Oskar

TABLES

2015

Vincent Van Duysen

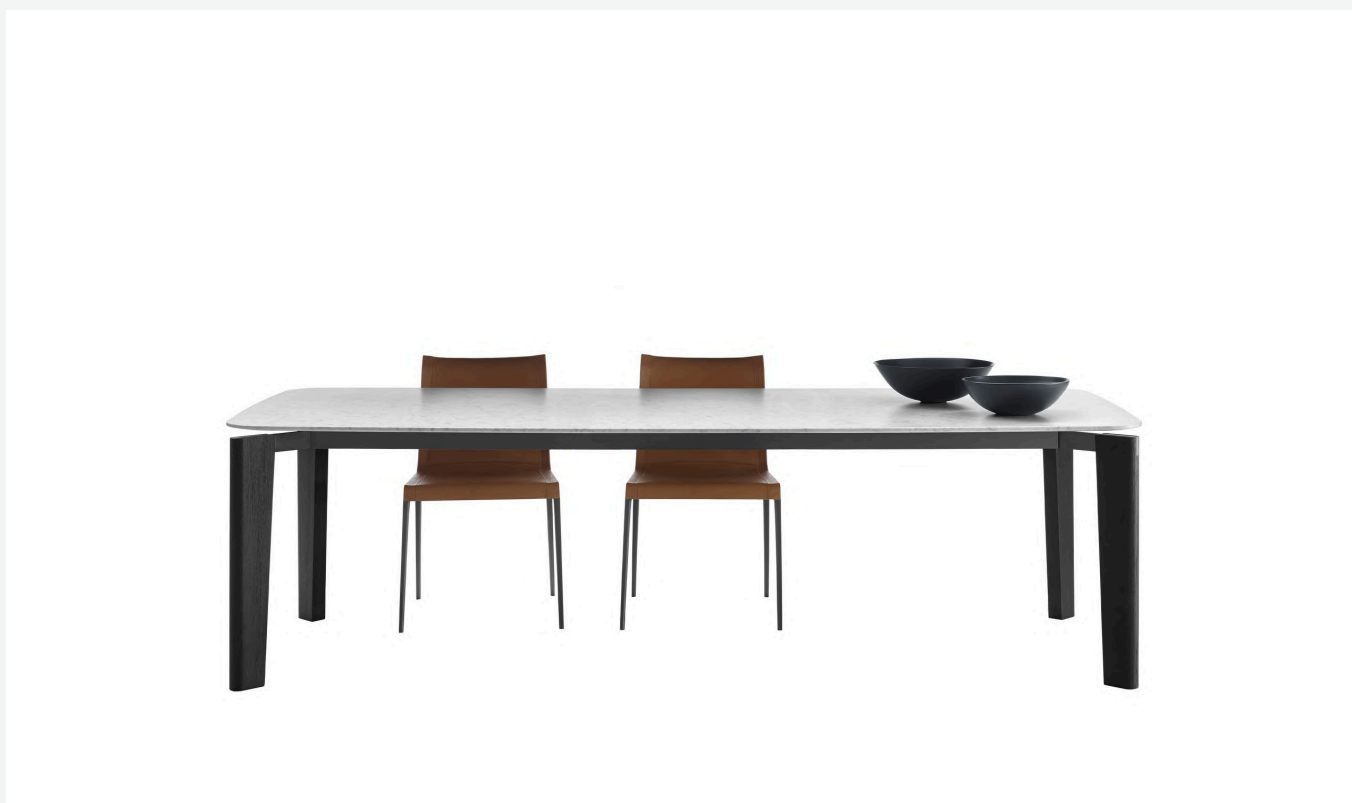

## Description

---

The architectural Oskar table, named after Oscar Niemeyer, one of the great masters of modernist architecture, stands out for its harmony of shape and for the tactile sensations of the various materials used. Its proportions, play of volumes and multiple finishes make it extremely customisable. In its most striking version, the top in cathedral glass with an irregular surface and a light green hue perfectly matches the lacquered legs in glossy emerald green. Oskar is available in three sizes: three rectangular and one square.

## Technical information

---

**Top**

wood particles panel and veneered solid wood, MDF wood fibre panel, glass or marble (matt polyester finish)

**Lower frame**

drawn steel

**Legs**

solid wood

**Ferrules**

felt

# Technical drawings

**TO150**

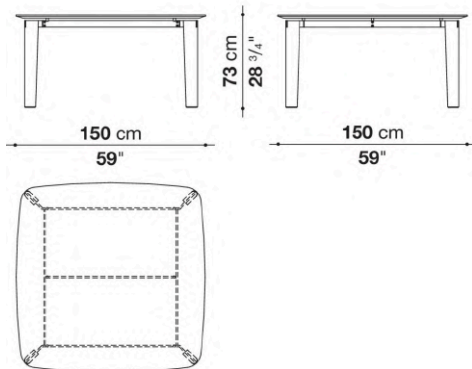

**TO245**

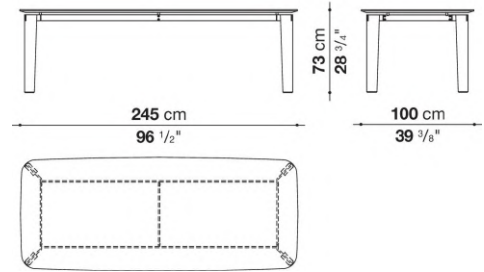

**TO300**

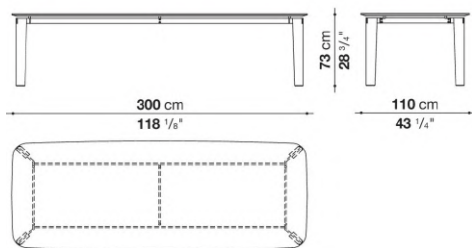

**TO200**

