

# Édouard

SOFAS

2016

Antonio Citterio



## Description

---

Édouard is a series of sofas with a strong aesthetic and functional appeal designed to enhance comfort with a wide seat and a high backrest, which can also be fitted with a headrest, studied to ensure efficient and excellent ergonomic support. Édouard offers in-line and modular sofas with terminal elements, corner pieces and chaise longues and matching seating elements designed to create restful areas that suit both the space available and the personal taste. The system includes an armchair in two versions. The upholstery is in fabric or leather with elegant relief stitching.

## Technical information

---

**Internal frame**

tubular steel and steel profiles

**Back and armrest internal frame upholstery**

Bayfit® flexible cold shaped polyurethane foam, polyester fibre

**Seat cushion upholstery**

shaped polyurethane of different density

**Feet**

aluminium

**Ferrules**

thermoplastic material

**Cover**

fabric or leather (raised stitching)

# Technical drawings

**ED183\_V**

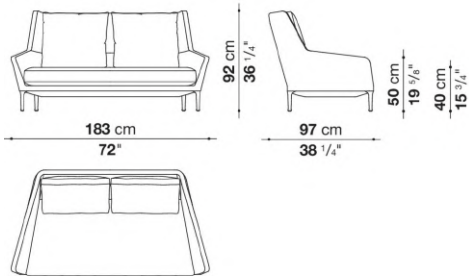

**ED225\_V**

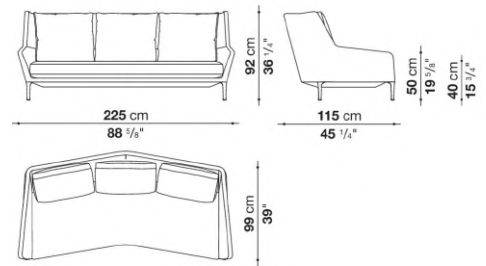

**ED255\_V**

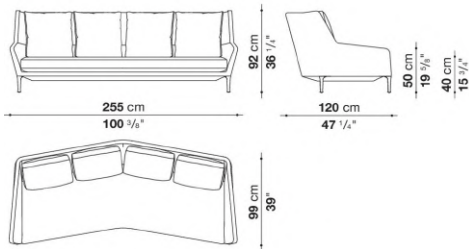

**ED176TAS\_V**

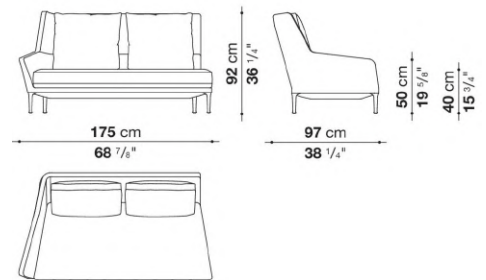

**ED176TAD\_V**

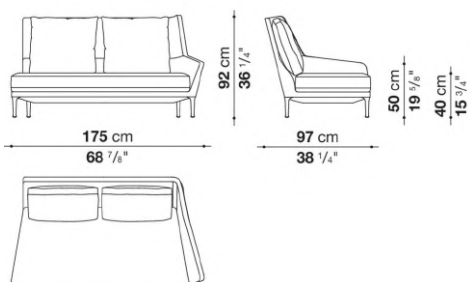

**ED183LAS\_V**

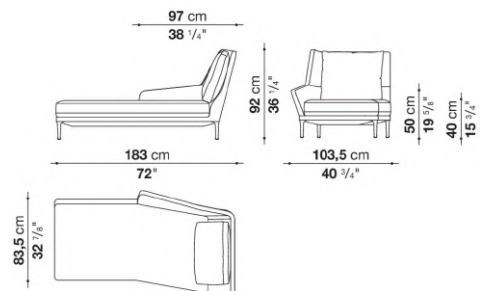

ED183LAD\_V

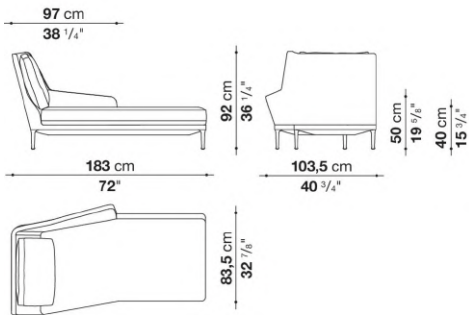

ED176TS\_V

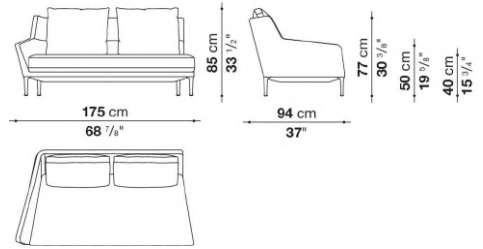

ED176TD\_V

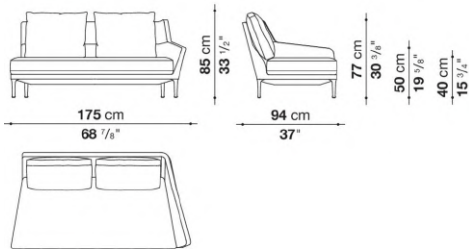

ED221TS\_V

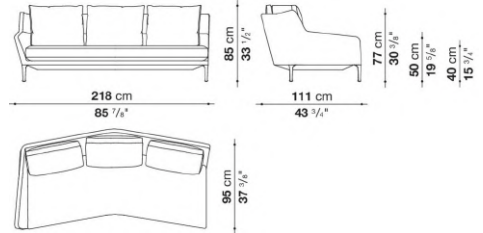

ED221TD\_V

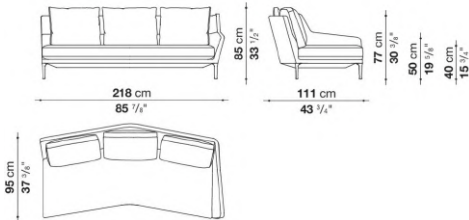

ED230AS\_V

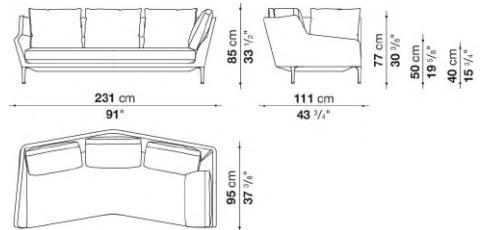

ED230AD\_V

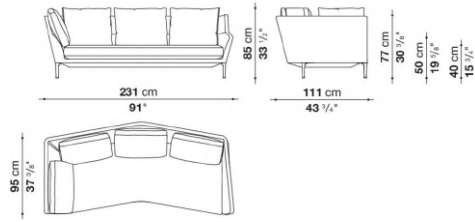

ED180LS\_V

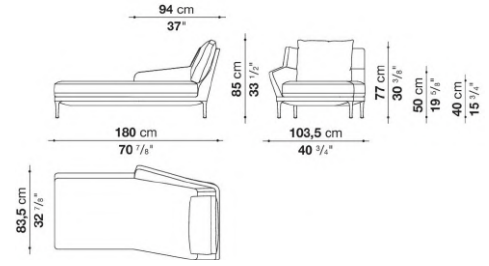

ED180LD\_V

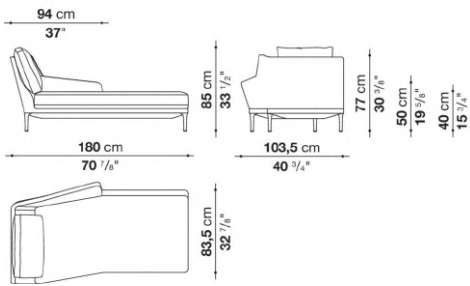

ED222LS\_V

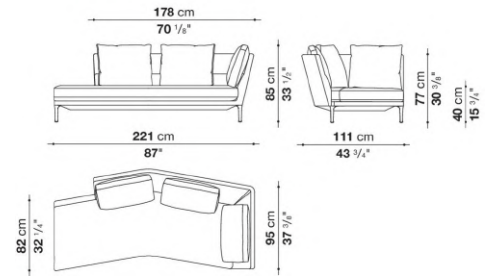

ED222LD\_V

