



EDEN ANTONIO CITTERIO 2010
BEDS/BED ACCESSORIES

EDEN | ANTONIO CITTERIO | 2010

Rigid base in plywood with polyurethane foam padding, covered with a protective laminated fabric

Storage base metal platform with wooden slats

Base with metal platform with wooden slats, adjustable to four height positions: 1st 4.5 cm, 2nd 7.3 cm, 3rd 9.5 cm, 4th 12.6 cm; double-check there is sufficient space to support the platform inside the bed, as shown in the figure

Bedframe in plywood with polyurethane foam padding, covered with a protective laminated fabric

Headboard in plywood covered with hide leather: russian red 5008, olive 5006, black

5005, dark brown 5004, dark brown extra 5013, grey 5003, sand 5001, tobacco 5015

In the eden plus version, the headboard has adjustable side panels also clad in cowhide

Feet in black plastic

The eden plus version has metal feet with satin, chrome, black chrome, burnished, glossy anthracite, matt titanium 710 finish

Upholstery is removable in both the fabric and leather versions

Please note: the platform with wooden slats is delivered divided in 2

pieces. Except for the version with storage base

COD. 015FL1

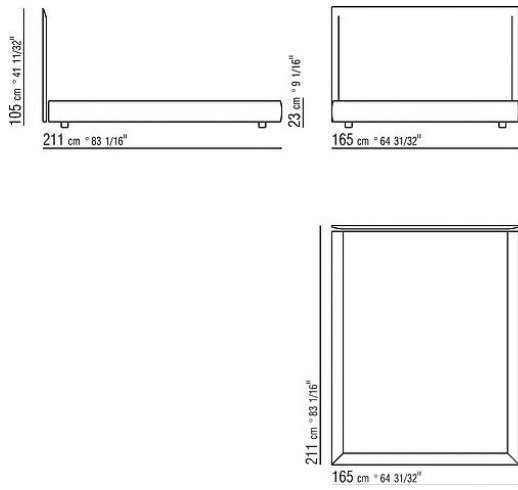

COD. 015FL2

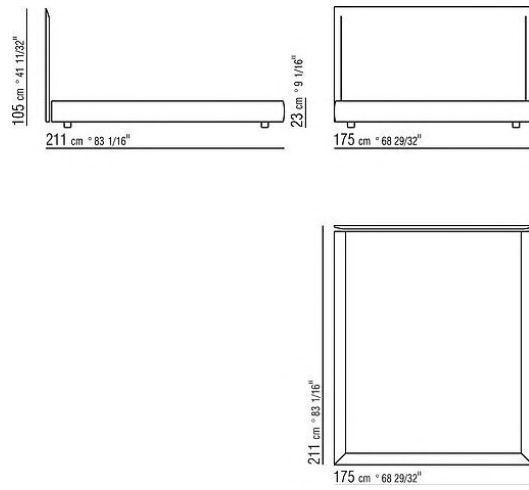

COD. 015FL3

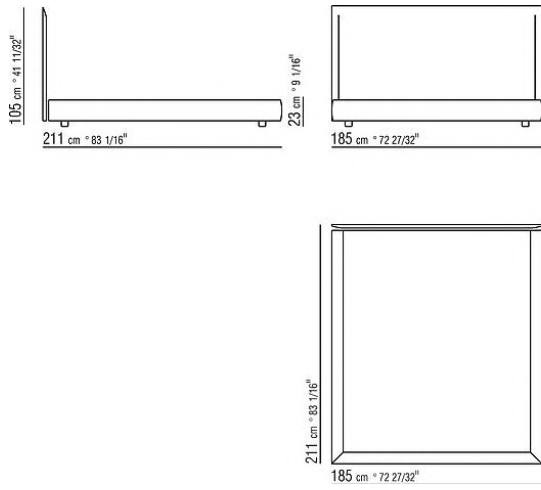

COD. 015FL5

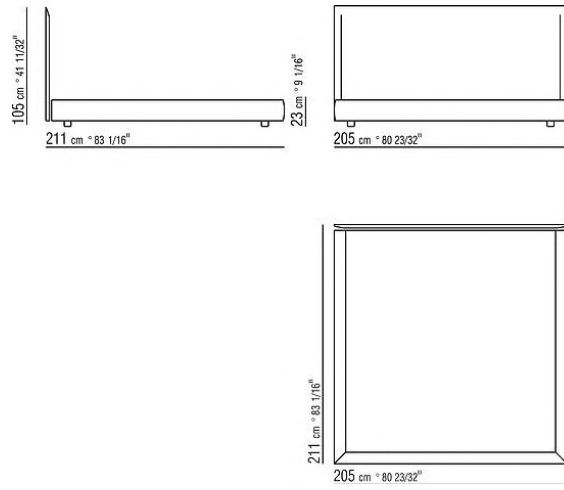

COD. 015FM1

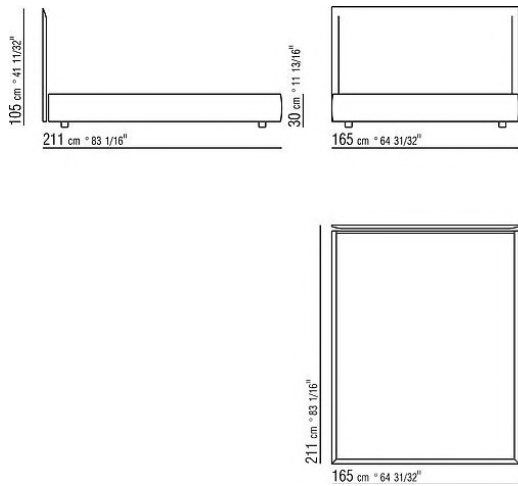

COD. 015FM2

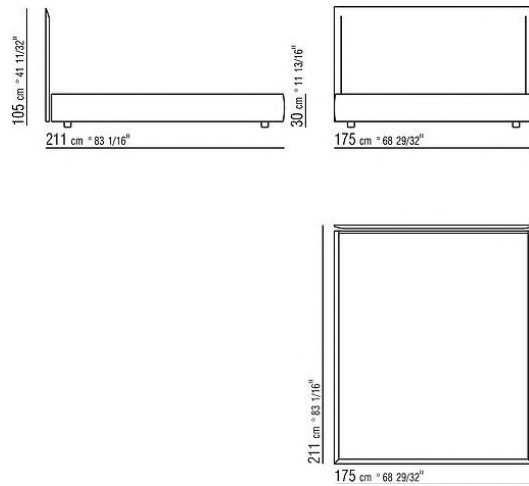

COD. 015FM3

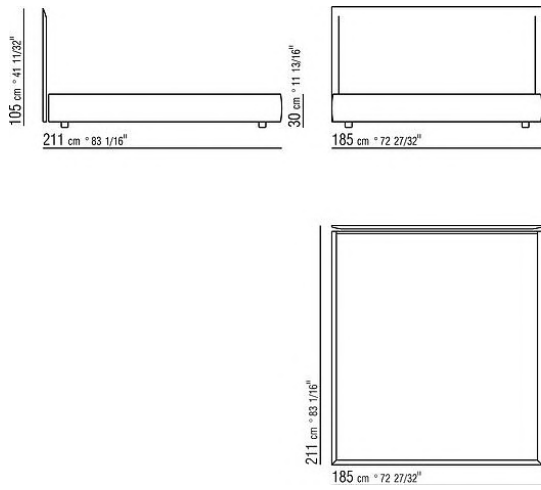

COD. 015FM5

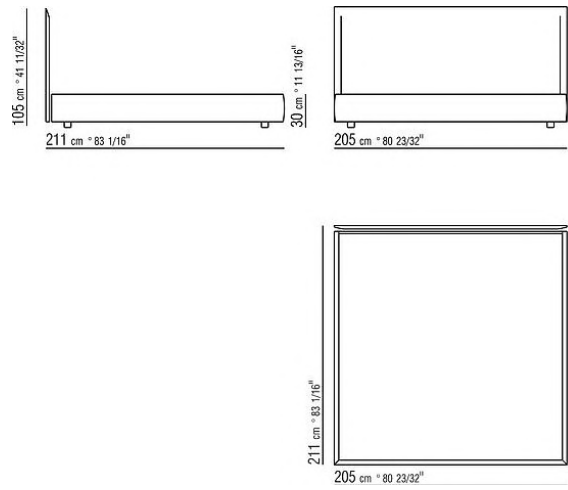

COD. 015FM6

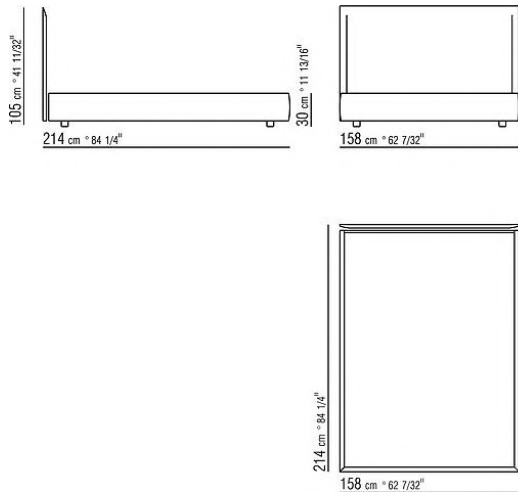

COD. 015FM8

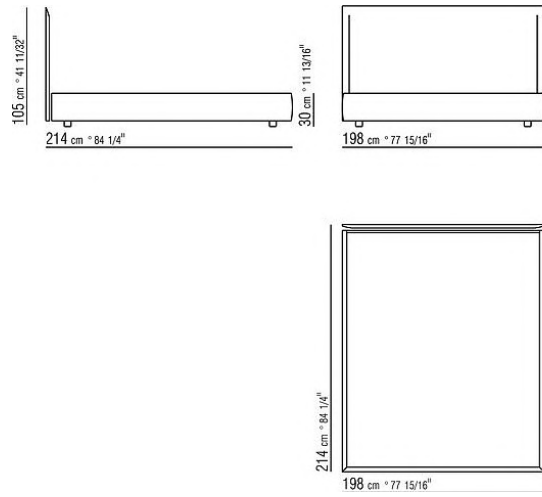

COD. 015FN1

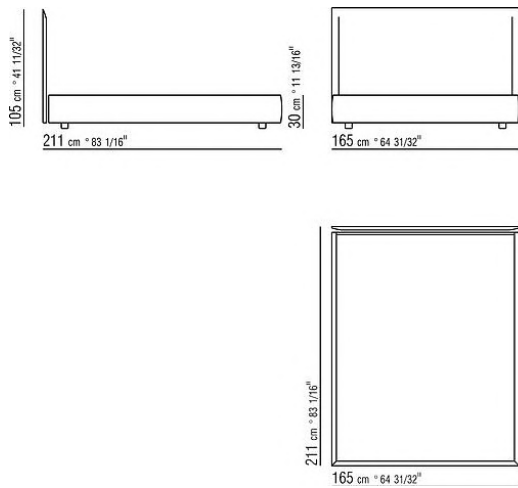

COD. 015FN2

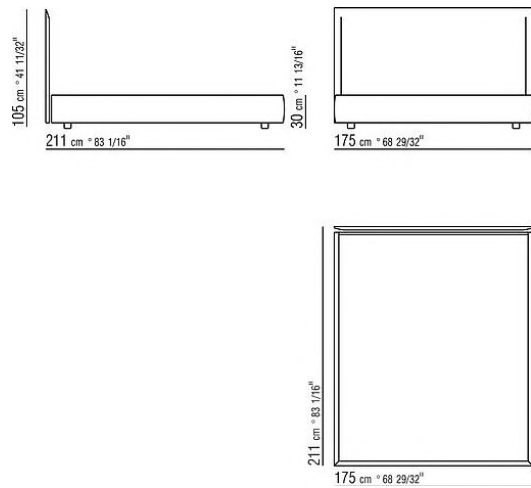

COD. 015FN3

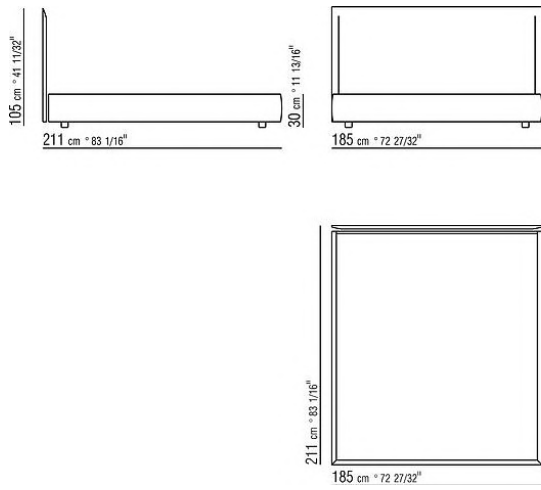

COD. 015FN5

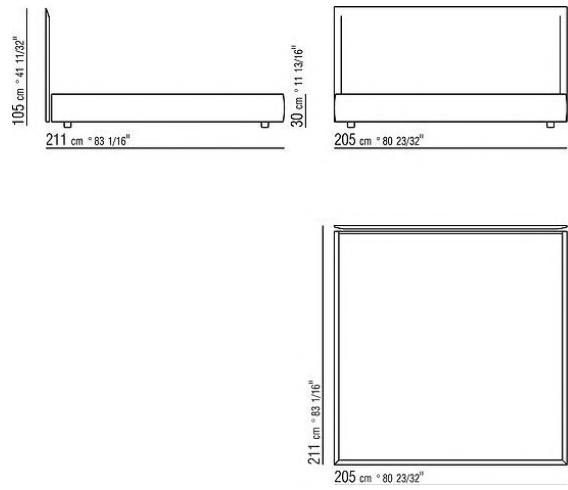

COD. 015FN6

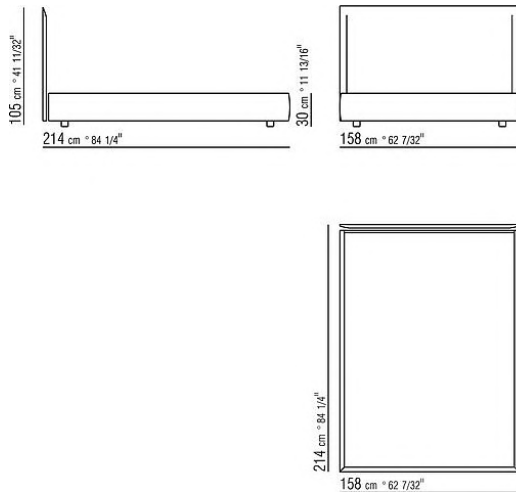

COD. 015FN8

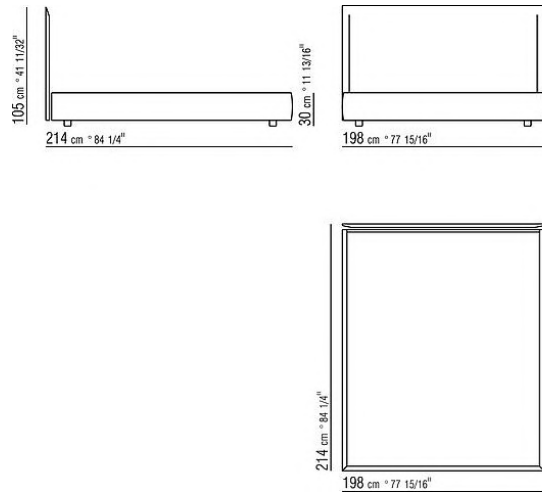

COD. 015FVA

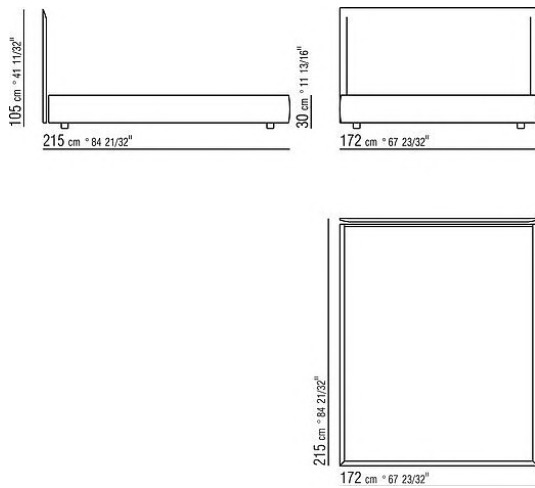

COD. 015FVC

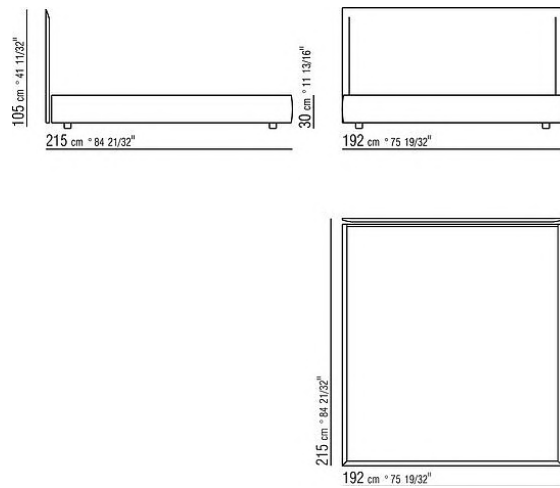

COD. 015FVE

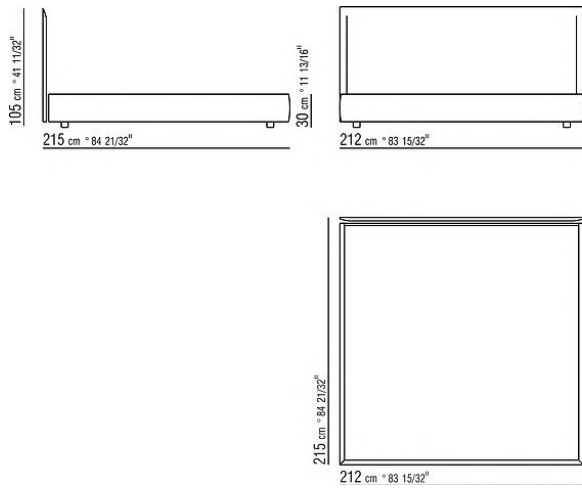

COD. 015FP1

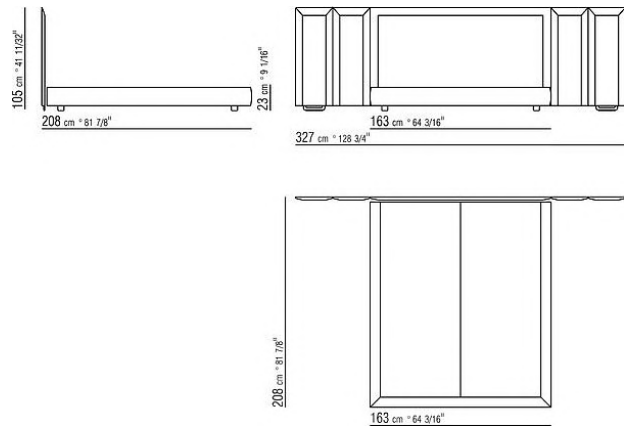

COD. 015FP2

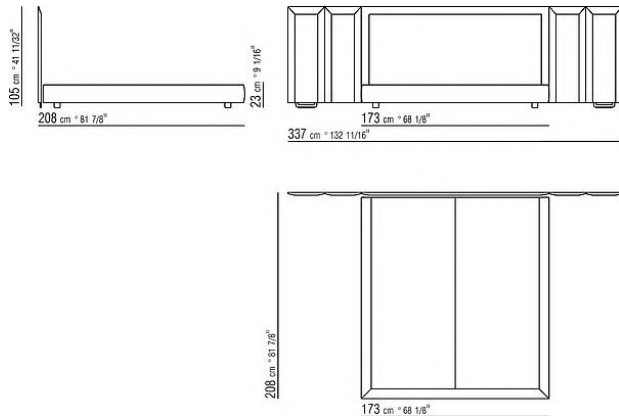

COD. 015FP3

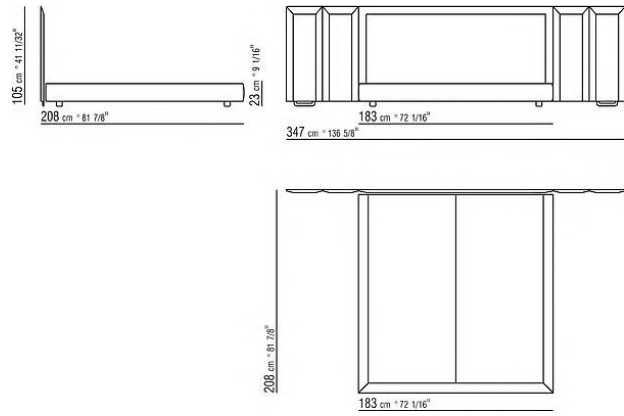

COD. 015FP5

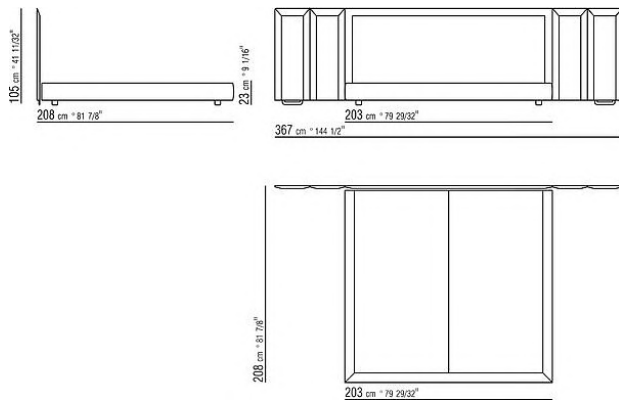

COD. 015FQ1

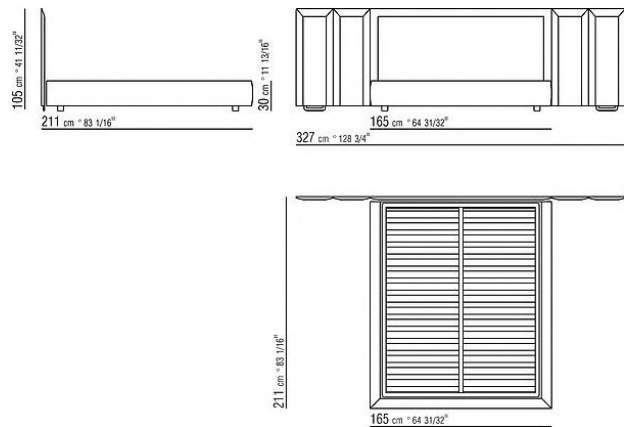

COD. 015FQ2

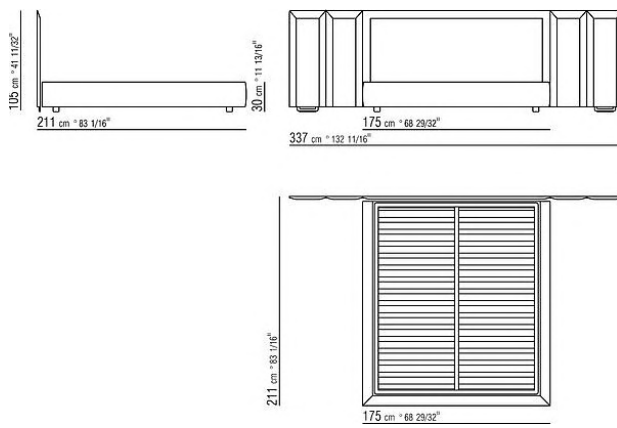

COD. 015FQ3

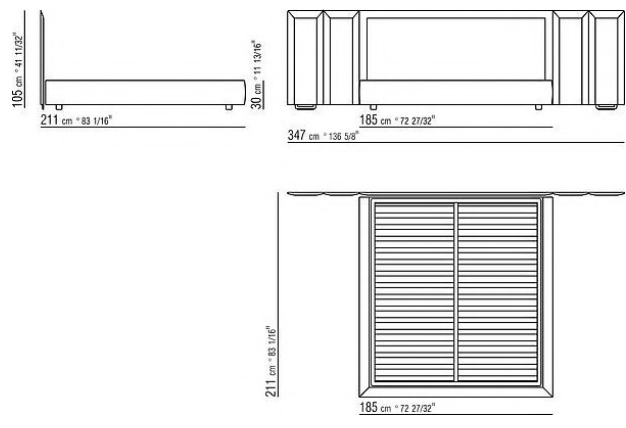

COD. 015FQ5

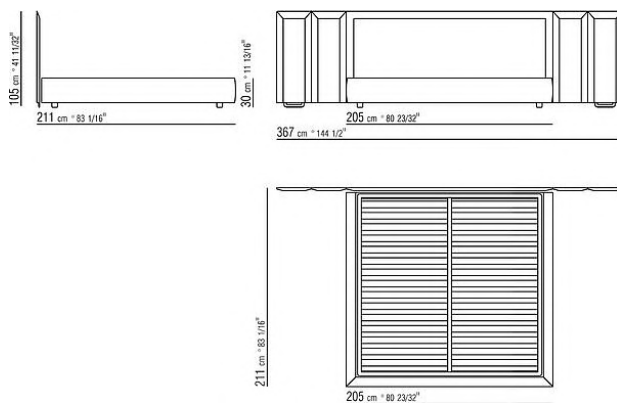

COD. 015FQ6

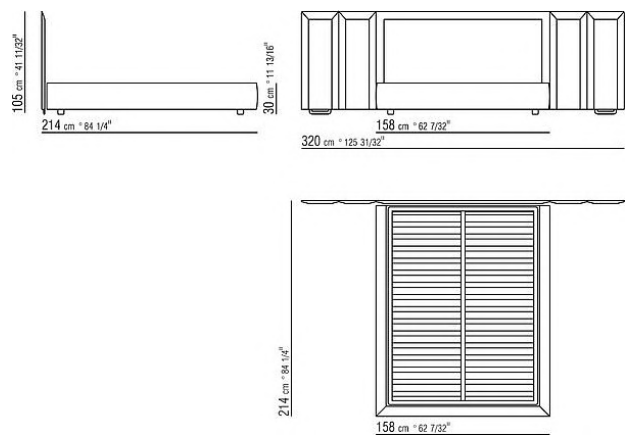

COD. 015FQ8

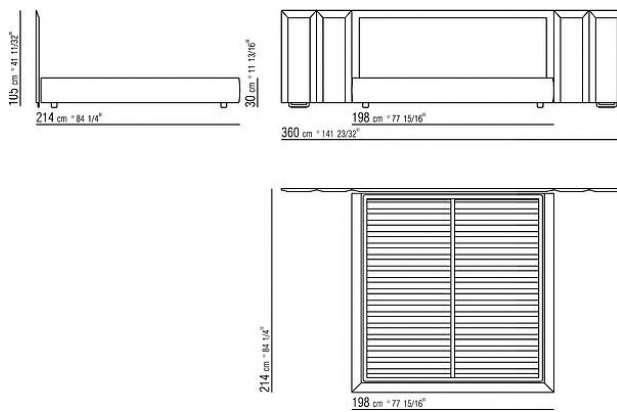

COD. 015FR1

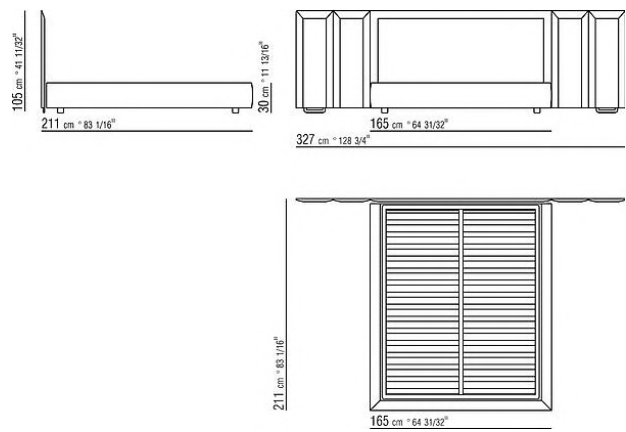

COD. 015FR2

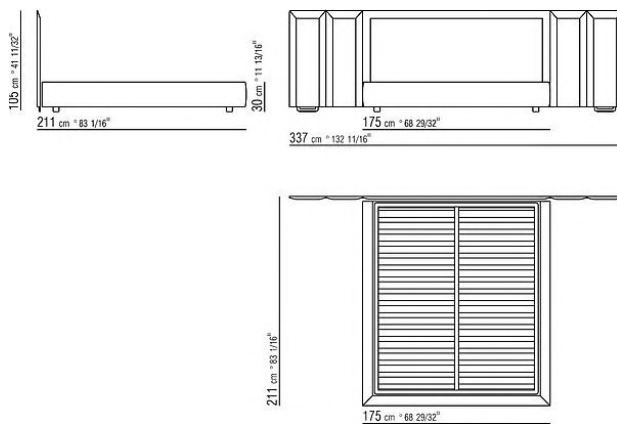

COD. 015FR3

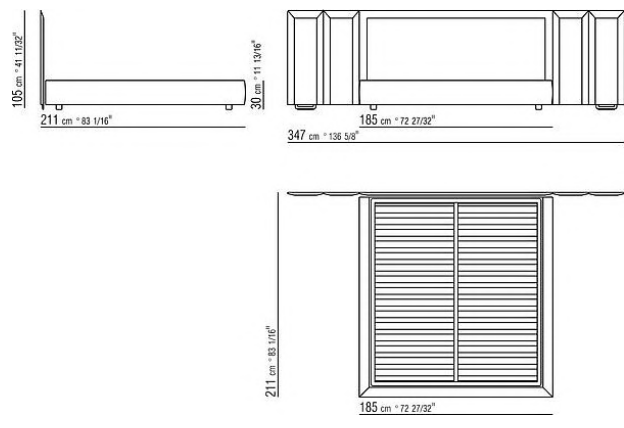

COD. 015FR5

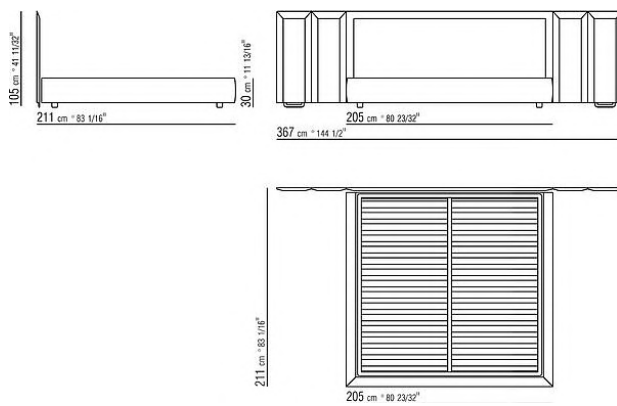

COD. 015FR6

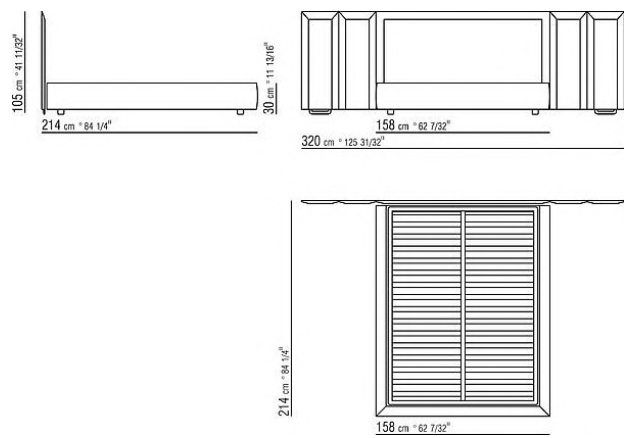

COD. 015FR8

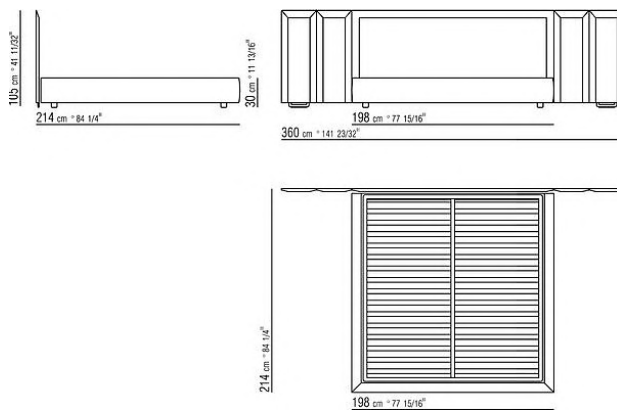

COD. 015FYA

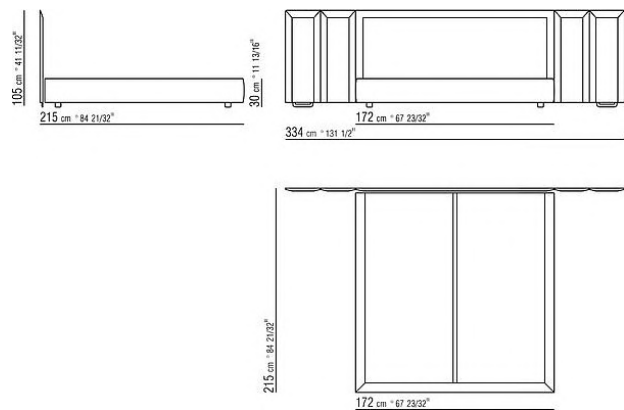

COD. 015FYC

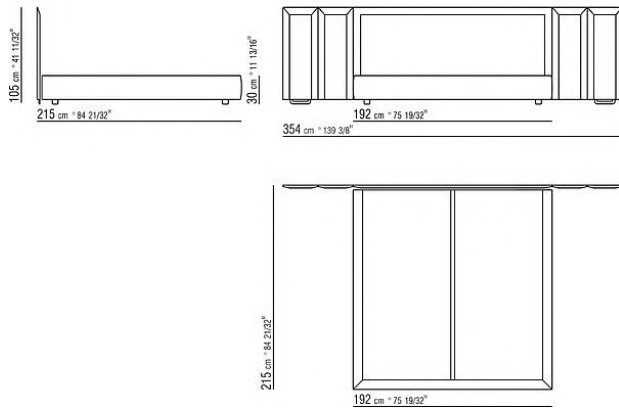

COD. 015FYE

